

AUXILIARY BRAKES FOR TRUCKS

Research into the behaviour of a tractor-semi-trailer combination
during emergency braking

R-76-18

Voorburg, 1976

Institute for Road Safety Research SWOV, The Netherlands

CONTENTS

Summary

I.	Foreword	2
II.	Introduction	3
III.	Purpose of the research	4
IV.	Present Legislation	5
V.	Emergency braking	7
VI.	Emergency braking performance	11
VII.	Technical solution and practical tests.	13
VIII.	Practical part of the research	16
IX.	Research results	22
X.	Conclusions and recommendations	34

References

Annex 1 to 19

SUMMARY

This report deals with an investigation carried out by a working group of the Institute for Road Safety Research SWOV.

Purpose of the research was to get an insight in various secondary braking systems for goods vehicles. Practical test were carried out with a tractor - semi trailer combination.

The performance of various split braking systems as well as spring brake actuators are shown.

With nearly all of the secondary braking systems it is possible to obtain sufficient deceleration to meet legal requirements for the braking path. The critical point however is the lateral stability. The report concludes with recommendations for legal requirements concerning lateral stability both on dry and wet road surfaces.

Conclusions:

- Lateral stability must be obtained on both a dry and a wet road surface
- Tractors for semi-trailers should have a split braking system
- Service brakes for motor vehicles and trailers (semi-trailers) should have a certain braking capacity in the case that somewhere a failure occurs (emergency braking capacity)

Proposed solution:

- Emergency braking capacity of the service brake shall be at least 50% of the normal required capacity

I. FOREWORD

During the GEF meeting in 1974, the Dutch delegation was asked to make a proposal for the requirements which motor vehicle auxiliary brakes (emergency brakes) should meet.

In support of this proposal the Minister of Transport and Waterways asked the Institute for Road Safety Research SWOV to undertake research into the functional requirements for auxiliary brakes. This research was carried out thanks to the collaboration of the Vehicle Research Laboratory of Delft University of Technology and Daf Trucks B.V., Eindhoven. The associated ad hoc working party on Emergency Brakes consisted of A. Dijks and W.A.M. van Blijswijk, of the Vehicle Research Laboratory of Delft University of Technology; J. van Genugten of Daf Trucks B.V., Eindhoven; G.J.M. Meekel of the Department of Road Transport RDW, The Hague, and L.H.M. Schlösser of the Institute for Road Safety Research SWOV, Voorburg.

In making an initial inventory of the problems, serious gaps were found in the legislation on auxiliary brakes, especially for trailers and semi-trailers. Hence, in complying with the terms of reference, the work was focused on arriving at functional requirements for auxiliary brakes for all the categories of motor vehicles falling within the scope of Regulation No. 13 and specified further in Sections 5.2.2., 5.2.3. and 5.2.4., together with the observations in Section 5.2.5. Two and three-wheeled vehicles were therefore excluded.

Besides a theoretical approach to the problem, it was considered advisable also to make practical tests for a number of specific categories, mainly trucks. In the first instance, the vehicle chosen was a tractor-semi-trailer combination, in the heaviest category.

II. INTRODUCTION

Trucks are involved in accidents more often than private cars. On Dutch national highways the truck involvement quotient is about 1.5 times higher than for private cars. On motorways the figure is a little lower [1].

Trucks differ from private cars in movement characteristics, dimensions and ergonomic features. Especially movement characteristics, longitudinal and lateral acceleration, are much more unfavourable for trucks. As regards deceleration, this is caused on the one hand by the lower braking and tracking force coefficients available with truck tyres, and on the other by the generally lower braking efficiency of trucks owing to the greater problems of braking force distribution. In accident research it will be particularly difficult to isolate the influence of each characteristic in contributing to the higher involvement quotient.

Although data are scarce, it can nevertheless be argued that in combatting traffic hazards the authorities should give priority to improving trucks. With many of the normal trucks it is not possible to perform a full emergency stop on a wet road surface at high speed without instability. The generally more severe consequences of accidents involving trucks also plays a part in assessing priorities. In connection with the request to the Dutch delegation, referred to in the Foreword, to work out a proposal for the requirements to be met by auxiliary (emergency) brakes, the background must thus be sought mainly in the finding that accidents which are contributed to directly or indirectly by trucks having defective braking systems generally have very serious consequences. It must be added that there are no requirements at all for emergency brakes for trailers or semi-trailers, while there are gaps in the case of tractor vehicles. Emergency brakes for trucks therefore form the subject of this study.

III. PURPOSE OF THE RESEARCH

Having regard to the terms of reference and especially the policy aspects of the research, the ad hoc working party formulated the following objectives:

1. Definition of emergency brakes;
2. Indicating possibilities of how emergency brakes can be obtained and testing the various systems in practice;
3. Comparison of the test results against systems already used in practice;
4. Drawing up functional requirements which emergency brakes must satisfy.

Starting from these objectives, the following procedure was chosen for the test aspects of the research:

1. Making a theoretical model with which the performance of the various emergency braking systems can be predicted;
2. Practical tests with the several types of emergency brakes with various external conditions such as road surface friction, speed and truck-load conditions;
3. Evaluation of theoretical and practical tests so as to arrive at functional requirements and proposals for policy measures.

Especially because of financial limitations, the work chosen in the first instance concerned a tractor-semi-trailer combination in the heaviest category. A combination of truck and truck and trailer is contemplated at a later stage.

In addition to testing emergency braking systems for tractor-semi-trailer combinations, the operation of the normal service brake was also thoroughly tested. In particular, it was examined to what extent ALB's on the tractor's rear axle and the semi-trailer axles satisfactorily comply with the regulations in 75/524/EEC.

IV. PRESENT LEGISLATION

The requirements for brakes beside or instead of the national requirements in various countries are combined in Regulation no 13 from Geneva and in Regulation 71/320/EEC from Brussels. Amending and extension of the requirements led in Brussels to the supplementary Requirements 74/132/EEC and 75/524/EEC.

In order to obtain an amended Regulation no 13 with the same contents as the latest Regulation of Brussels in GRF is stated to wait untill the supplements of the Brussels' Regulations would be ready. It is to be assumed that in short time Regulation no 13 will be changed similar to the Regulations of Brussels. The next chapters must be read with this condition in mind.

The present requirements for motor vehicle braking systems in the EEC are given in 71/320/EEC and 75/524/EEC. In the former, provisions regarding auxiliary brakes can be found in paras. 2.1.2.2., 2.2.1.2., 2.2.1.4. and 2.2.1.19. of Annex I and para. 21.2. of Annex II.

Summing up the requirements, it is found that private cars, trucks and buses have to have a service brake, an auxiliary brake and a parking brake. If the service brake becomes defective, the brakes of such vehicles must have a certain residual effect. These residual effect requirements are usually lower than for auxiliary brakes. If the auxiliary braking effect is obtained from the residual effect of the service brake the requirements are the same. The residual effect need not exist for tractors with semi-trailers if the transmission of the semi-trailer service brake is independent of that of the tractor vehicle.

Trailers of the O_1 type need not have a service brake. Trailers (also including semi-trailers) in categories O_2 , O_3 and O_4 must have a service brake, however. Every trailer or semi-trailer requiring a service brake must also have a parking brake. No trailer

or semi-trailer needs to have an auxiliary brake. Nor, in the event of the trailer's or semi-trailer's service brake failing need there be any residual effect. This means, therefore, that if a trailer's or semi-trailer's service brake fails, the vehicle cannot be braked in any way at all. Conversely, there are regulations concerning braking of trailers or semi-trailers if the tractor vehicle's service brake fails.

Para. 2.2.1.19. stipulates that the heaviest category of trailers (O_3 and O_4) must be brake controlled if the auxiliary braking system of the tractor vehicle is operated. Furthermore, the trailer must be braked with the remaining part of the service brake if its transmission consists of two parts and one part fails. Further, such trailers and semi-trailers must also be brakable if there is a leakage or rupture in the pneumatic connection between the tractor and the trailer or semi-trailer.

As regards braking force distribution, para. 2.2.1.8. stipulates that the effect of the service brake must be rationally distributed over the axles. What this means is elaborated in 75/524/EEC. No requirements are made regarding auxiliary brakes or the residual effect of the service brake as regards braking force distribution. But it is generally stipulated that in braking tests on a dry road surface with reasonable friction none of the wheels must lock.

V. EMERGENCY BRAKING

In the definition of auxiliary brakes it is stated that the vehicle must be able to be stopped within a reasonable distance if the service brake fails. In doing this, the driver must be able to retain control of the steering mechanism with at least one hand.

In view of the definition of an auxiliary brake this is obviously intended for stopping the vehicle if a failure becomes apparent. This does not necessarily mean that there must be an emergency. This only happens if an effort has to be made to avoid an accident if the service brake is not fully effective.

In view of the above, therefore, if the service brake fails emergency braking can be regarded as: either the residual effect of the service brake or the auxiliary brake. Under present conditions there is not always a guarantee that the shortest braking path is obtained with emergency braking. This may be because the system with the lowest deceleration is used or because time is lost by changing over to another control, and on the assumption that the driver is aware or is informed of the defect in the service brake.

Let us analyse the driver's actions in an emergency.

Lost times

If the braking system is fully operative, the following times can be defined:

reaction time t_r

- this is the time elapsing from the moment the emergency is observed until the moment the driver touches the brake pedal.

Lost time t_v : this time consists of the reaction time plus half of the swell time.

Values measured in tests show the following pattern [2].

	t_r	t_v	
50 percent of tests	0.51	0.67	for private cars with
			to hydraulic foot brakes
		0.77	
95 percent of tests	0.73	0.97	
			to
		1.06	

Other measurements give the following value [3]. The average value of lost time t_v was 0.9 sec. In this case, 25 percent of the group investigated had a lost time of 1.2 sec., while in some cases it was even more than 2 sec.

If the service brake becomes defective, a number of cases can be distinguished. If the driver is aware of the failure he can be assumed to stop his vehicle before an emergency arises.

If the failure becomes apparent at the moment of depressing the brake pedal and the driver keeps the pedal pressed down the lost time t_v remains unchanged but the average deceleration is lowered and the braking path lengthened.

It is quite conceivable, however, that the driver is taken by surprise by the failure at the moment of depressing the brake pedal, releases it and depresses it a second time, on the assumption that he will then have the full braking capacity available. With a hydraulic braking system as well as with an air pressure braking system the stimulus for the driver is the deceleration. The reaction to press the brake pedal twice also occurs with a hydraulic braking system if the distance the brake pedal travels is insufficient to obtain maximum braking pressure. This situation gives an extra lost time t_{re} : waiting time establishing that service brake does not work properly; taking decision to try again followed by lost time due to reapplying brake pedal.

If the driver has a separately operated auxiliary brake and applies this immediately he detects the failure then t_{re} is related to

the auxiliary brake and the time lost in operating it. The last possibility is that the driver does not apply the auxiliary brake until the brakes fail to function after he has pressed the brake pedal for the second time. This results in:

Lost time auxiliary brake t_{vr} = waiting time; finding that the service brake does not work; deciding to apply auxiliary brake followed by lost time owing applying auxiliary brake.

No data are available regarding the driver's actions in an emergency and the length of times t_{re} and t_{vr} . Since t_r is about half the total lost time, it can be estimated that for two applications, or one application and once with the auxiliary brake the total lost time will be about 1.5 to 2 times greater than with the service brake. For two applications plus one application of the auxiliary brake this estimate is about 2 to 2.5 times that of the lost time with the normal service brake.

The consequence of this reasoning is that an emergency brake as the remaining part, the residual effect of the service brake will show the least lost time. If a separately operated auxiliary brake is nevertheless to be admitted as an emergency brake, then the average deceleration of the auxiliary brake will have to be greater to meet the same requirement regarding braking path as the residual effect of the service brake.

In order to obtain an idea of the extent of this higher deceleration, the following example has been worked out. If we take the requirements for the auxiliary brake for trucks (categories N_1 , N_2 and N_3) the maximum braking path is $S = 0.15V + 2 \frac{V^2}{115}$. Bearing in mind that this is a braking test, the driver's reaction time plays no part. The regulations in para. 2 of Annex II of 71/320 do not state for what time the average deceleration should be calculated. Having regard to the build-up and swell times, it can be assumed that this applies during the second term of the above double term. If we take an extra reaction time of 1 sec. for the emergency brakes, this gives the following pattern:

	$v_o = 70 \text{ km/h}$		$v_o = 50 \text{ km/h}$		$v_o = 40 \text{ km/h}$	
	$s_{tot} = 95,7 \text{ m}$		$s_{tot} = 51 \text{ m}$		$s_{tot} = 33,8 \text{ m}$	
	s_{eff}	d_m during $s_{eff} \text{ (m/s}^2\text{)}$	s_{eff}	d_m during s_{eff}	s_{eff}	d_m during s_{eff}
no lost time	85.2	2.2	43.5	2.2	27.8	2.2
extra lost time of 1 sec.	65.8	2.9	29.6	3.3	16.7	3.7

v_o = initial speed

s_{tot} = total braking path

s_{eff} = braking path when average deceleration occurs

d_m = average deceleration

Lastly, it should be mentioned that if a higher deceleration is required with a limited number of wheels, there is a danger of one or more wheels locking, especially on a wet surface. This may affect track stability. This is dealt with in the following section.

VI. EMERGENCY BRAKING PERFORMANCE

In braking, there are three criteria for judging the braking system: maximum braking path, minimum deceleration and stability. If we take for emergency brakes the requirements for auxiliary brakes, then it is stipulated that the auxiliary brake must satisfy a type 0 test (para. 2.1.2.4. of Annex II of Regulation 71/320/EEC). This lays down the requirements for braking path and deceleration. Para. 1.1.3.7. of Annex II stipulates that the prescribed effect of the braking system must be obtained without wheels locking, without the vehicle leaving its track and without abnormal vibration. This must take place subject to the provisions of Para. 1.1.3.4. that the road surface must have a good friction coefficient.

For the service brake there are also regulations for lower friction coefficients, but not for auxiliary brakes. This means that an axle not locking on a rough surface may lock on a wet surface, especially when the full braking capacity is used in an emergency. In actual fact, therefore, besides the requirement of braking path and deceleration, there must also be a stability criterion for both rough and smooth surfaces.

In the case of the service brake this is solved by making regulations for the brake pressure on the wheels related to wheel load. This also indicates the sequence of axle locking.

This solution is not always applicable to an emergency brake and if only one axle is used in emergency braking then there is no longer any question of braking force distribution or locking sequence.

Based on practical conditions, a possible criterion might be to stipulate a specific road width which the vehicle must not go beyond during its entire braking path. The force then applied by the driver to the steering wheel must not exceed a given value. The advantage of such a requirement is that this is quite clear and easy to establish in most cases. A jackknifing vehicle will not be able to meet this requirement. Difficulties are likely when the driver's skill plays a part in marginal situation. This may

be a source of misunderstanding especially during testing. Moreover, the flatness of the road surface laterally is important because practically all roads are banked to ensure good water disposal. This flatness should be accurately specified for braking tests.

A drawback to this criterion is that if it is satisfied vehicle control is not guaranteed in certain cases, for instance if the front wheels lock. There is then no longer any scope for evasive action. Nevertheless, it must at all times be avoided that the vehicle runs off its track uncontrolled or jackknifes.

In any event, international agreement will have to be reached. So far, the most concrete proposal for a stability criterion is a British one, as follows:

During a braking test the vehicle must remain for the entire length of its braking path within a lane 12 feet wide or $1\frac{1}{2}$ time the vehicle's width, whichever be less. During this, it is permissible for the driver to take action with a moment on the steering wheel not exceeding 30 Nm.

Testing

As stated above, it is practically impossible to evaluate an emergency braking system merely with braking tests on a dry, reasonably rough road surface. Track stability cannot always be ascertained arithmetically either.

It is therefore advisable to extend emergency brake testing to tests on a wet surface. These conditions can be achieved fairly simply with a sprinkler installation. It is important that the road surface is very well defined.

An interim solution might be to test various systems and, with reference to this, forbid certain systems by means of regulations. Another and better solution is to make tests on a roller testing assembly.

VII. TECHNICAL SOLUTIONS AND PRACTICAL TESTS

A way of dispensing with tests on wet road surface is to make the emergency brakes so that they meet the regulations for service brakes with the exception of those regarding braking path and deceleration. The most expensive solution is that of duplicating the service brake transmission. A less expensive solution is at all times to utilise half the braking capacity of the front axle and half that of the rear axle. As regards the use of diagonal circuit separation (one front wheel and one rear wheel) doubts continue to exist regarding track stability. Utilising half the braking capacity of both front wheels and that of one rear wheel calls for special brakes on the front axle, i.e. wedge-brakes by air pressure systems or dual circuit disc brakes. With articulated vehicles reaction forces occur between the towing vehicle and trailer or semi-trailer. These can influence the stability. The extent of these reaction forces depends on the way the braking power of the semi-trailer is realised. A semi-trailer with a tandem axle and two separate circuits can show big differences if the tandem axle is not compensated for the weight transference and one or the other circuit fails.

The Introduction stated that research was undertaken into the emergency braking behaviour of a tractor and semi-trailer. This to obtain a good insight in the above mentioned problems of lateral stability and the influence of the reaction forces with articulated vehicles. In combination with the theoretical approach functional requirements have to be drawn up for emergency braking systems. From this recommendations legal requirements have to be derived.

In view of the great variety of braking systems in tractors and semi-trailers allowed on the roads (for instance the various types of circuit separations and the single or double piping systems), a choice was made from among these. The choice was based on a combination provided by DAF consisting of a DAF FT2800 tractor and a tandem axle semi-trailer (see Annex 1 and 16). The tractor had the standard dual circuit braking system

and automatic load brake apportioner (ALR) on the rear axle. The circuit separation is such that if one circuit fails either the front axle or the rear axle remains braked. The semi-trailer's brakes are operated via a double piping system. The semi-trailer has a hand operated control with which the pressure to the brake cylinders can be regulated depending on the truck's load. This control has three positions: empty, semi-loaded, fully loaded. The semi-trailer's tandem set has no compensator for the weight transference occurring during braking.

For testing purposes, the tractor's braking system was modified; by adjusting a number of valves a diagonal circuit separation could be obtained with which only the left front wheel and the right rear wheel could be operated. It was also possible, by means of valves, to brake only the front or rear axle.

The semi-trailer's braking system could also be similarly adapted (see Annex 2). All the brake cylinders were spring brake actuator cylinders. They could be operated so that each axle could be braked individually. Diagonal braking was also possible with them (both with the tractor and the semi-trailer). Illustration 2 (Annex 16) shows two of the fifteen added valves.

Criteria

There were two criteria for evaluating the results:

1. The stability of the vehicle or combination.
2. The average deceleration or braking path.

As there are not (yet) any statutory requirements regarding stability during braking, the working party drew up a number of criteria itself for this research, both for solo tractors and for combinations.

These criteria regard stability as inadequate:

- a) If the solo tractor: (i) forms an angle of 20° or more compared with the driving direction; (ii) shifts more than one metre to left or right.
- b) If the combination: (i) jackknifes so that the angle between the tractor and the semi-trailer exceeds 10° ; (ii) shifts more than one metre to left or right.

The driver did not correct the combination in order to obtain a reproducible testprocedure. If it appeared during measurement that instability was easy to correct, braking was evaluated as stable.

Deceleration was adequate when the average deceleration was at least $2,2 \text{ m/s}^2$ even in the case of higher initial speeds as mentioned in par. 2 of Appendix II of 71/325/EEC.

The investigations assumed that in principle only one failure could occur at a time. Emergency braking in this context means any braking in which there is a defect in the braking system of the tractor or the semi-trailer. Possible defects are a leaking pipe or a defect in the ALR etc.

VIII. PRACTICAL PART OF THE RESEARCH

1. Measuring programme

A large number of measurements were made with the braking systems described above. Each such braking system was measured at two speeds (40 km/h and 80 km/h), and two road surfaces (dry and wet). There were also two conditions of loading: laden and unladen. The gross vehicle weight fully loaded was 325.000N.

The measurements can be subdivided into three main groups:

1. The residual effect of the service brake (i.e. the ordinary foot brake) when a circuit fails;
2. The effect of the braking system when the hand-operated auxiliary brake (spring brake actuator) is used on several axles;
3. The influence and effect of the ALR (on the tractor) and the hand operated control valve (on the semi-trailer).

Each main group can again be split into three sub-groups:

1. The solo tractor;
2. The tractor with an unladen semi-trailer;
3. The tractor with a laden semi-trailer.

A total of 200 measurements were made. For a schematic presentation of the measurements see Annexes 3, 4 and 5.

2. Measuring site

The measurements were made on a section of National Highway E8 not yet open to traffic, near Enter, in Overijssel.

The measurement conditions there were practically ideal. Measurements were made in two directions on carriageways 12 metres wide with a lateral incline of 1:50. The length of the section was quite ample.

With the aid of a sprinkler installation one road section (150 metres long) was kept constantly wet so that for each adjusted braking system measurements were made first dry and then wet. The water for sprinkling was pumped from a brook. Illustration 1 (Annex 16) shows the sprinkler installation by the road quite clearly and illustration 3 (Annex 17) shows how the road surface

was wetted sufficiently over its entire width.

The measuring truck of the Vehicle Research Laboratory of Delft University of Technology measured the friction coefficients on the measurement sections. This vehicle is a truck equipped with measuring and recording equipment and a single-wheel trailer fitted with the same tyre as the articulated vehicle (See Illustration 8, Annex 19). During the measurements the vertical load on the measured tyre was 25,000N and the tyre pressure 6.25 bar. Measurements were made on both a dry and a wet road at speeds of 90 to 10 km/hr.

The measuring wheel was braked at a constant speed, and μ_{xm} , the maximum braking force coefficient before the wheel locked, and μ_{xb} the braking force coefficient with the wheel locked, were determined.

The measurements were repeated several times and the results are given in the diagram (Annex 6). As this diagram shows, the surface was rather rough, so that comparatively high decelerations were possible.

It is striking that at low speeds the braking capacity coefficient with a locked wheel on a wet surface is higher than on a dry surface. This is probably due to temperature effects.

On a wet surface the tyre cools better than on a dry surface, because with a locked wheel the rubber shows signs of combustion in the area of contact. It must, however, be borne in mind that the measurements were started at high speeds, and that at low speeds, in the final measurements, the tyre had already heated up considerably.

As in previous measurements, it was found that the tyre is more inclined to lock when the brakes are applied hard, at one or more fixed positions round its circumference.

3. Measured values

In each measurement the following factors were recorded:

1. speed v
2. deceleration a
3. braking path s

4. the angle φ between the tractor and semi-trailer
5. the pressure p in the brake cylinders
6. the time t_B after which a wheel locked
7. the duration t of the measurement

After each measurement the vehicle's position relative to the driving direction was sketched. In a number of cases the temperature of the brake drums was measured.

4. Measuring equipment

4.1. The speed v was measured with a Peissler fifth wheel. Illustration 4 (Annex 17) shows how this wheel was fixed on the semi-trailer. For solo measurements this wheel was placed behind the tractor's right rear wheel. The vehicle's speed could be seen directly in the cab from a meter belonging to the wheel. The speed signal was noted on a UV recorder.

4.2. Deceleration during braking was measured with a (Donner) accelerometer. The recorder was located in a box on the tractor, as shown in Illustration 5 (Annex 18). To avoid the semi-trailer touching the box in a bend it was positioned at an angle. The recorder signal was amplified and recorded.

4.3. After each measurement the braking path s could be seen from the Peissler box. By fitting a switch to the brake pedal, the commencement of each braking was determined. The commencement of braking was marked on the paper strip.

4.4. The angle between the tractor and semi-trailer was measured with a rotary potentiometer. This was made possible by fitting a semi-circular disc near the connecting point on the semi-trailer, with a steel wire over it. The potentiometer was fixed to the tractor frame. A disc was also located on the potentiometer with the wire wound round it several times (see Drawing). In this way there was a fixed transmission of 1:10. The potentiometer was incorporated in a bridge. Its signal was recorded.

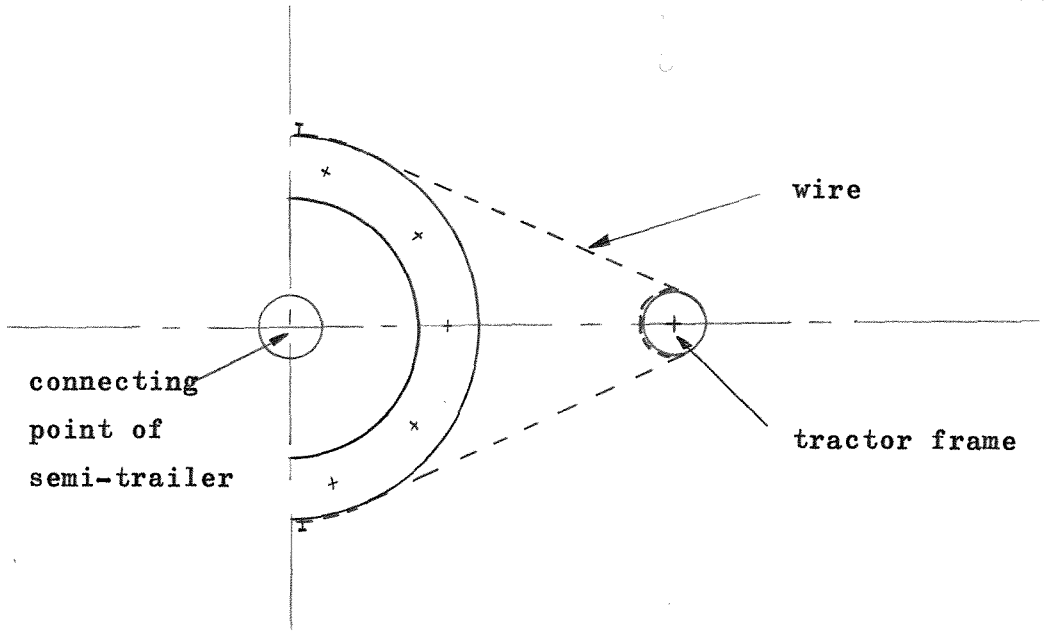

4.5. The pressure in the brake cylinders was measured with quartz pressure transducers (Kistler). Each transducer was compensated for accelerations. One transducer was fitted per axle, as close as possible to the brake cylinder. The charge amplifiers belonging to these transducers were placed close to the transducers to avoid the signal being weakened too much in the (special) transducer cable. Illustrations 5 and 6 (Annex 18) show the boxes in which the charge amplifiers were placed. These boxes were fully insulated in order to preclude inaccuracies owing to temperature variations.

4.6. It was fairly simple to establish whether a wheel locked or not. Reed relays were used for this; these are relays which close under the influence of a magnetic flux. They were connected in series-parallel with two resistances as shown below:

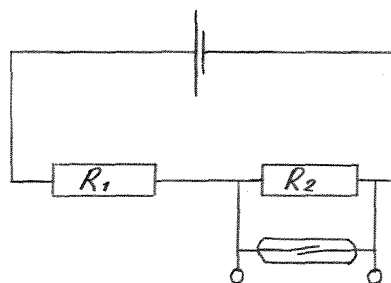

With an opened relay the voltage drop across R_2 is known. With a closed relay it is zero. By fitting the relay on the (stationary) axis of the semi-trailer and fixing a small magnet on the (rotating) hub it was possible to ascertain from the voltage across the relay whether the wheel was turning or not. In the former case the voltage showed a step function and in the latter a constant function.

On the tractor, the magnet was glued to the edge of the rim, and the relay was placed in a plastic block on the brake-drum protecting plate.

In this way, each wheel had a relay. Illustration 6 (Annex 18) shows how the relay wiring on the semi-trailer axles was fixed to brackets. The signals from two relays (per axle) were noted on one channel of the UV recorder. By suitably selecting R_1 and R_2 it was possible to make the voltage drop across R_2 for the left side of the combination twice as great as for the right side. After totalling two signals it thus remained possible to establish which wheel was locking. The time t_B after which this happened, as from the commencement of braking, could be read from the paper strip.

4.7. The measuring time was not directly recorded, but was easy to ascertain because the commencement of the measurement was determined by marking and the end was at $V = 0$.

4.8. The temperature of the brake drums was noted in order to find out whether the drums were cooled sufficiently to start the next test. Since it soon transpired that the time needed for converting the braking system was adequate for cooling the brakes, the temperature was only measured in case of doubt.

4.9. As stated earlier, all the signals were noted on a UV recorder. A Brush recorder was used with which 11 signals could be recorded. For the twelfth signal, the marking, a separate galvanometer was used.

4.10. All the equipment could be fed from the tractor's 24 volt system by using converters. The equipment was placed on the bunks in the cab. Annex 7 shows a block diagram of the equipment.

The driver was instructed to apply the brakes hard if possible. In the first instance, it was assumed that the steering would not be corrected (except for reasons of safety). Later, it was examined in a number of measurements to what extent the steering could be corrected. In order to avoid the combination jackknifing, a chain was fixed to limit the jackknifing angle.

IX. RESEARCH RESULTS

1. Results of computations

A series of diagrams shows the relationship between the required friction coefficient k as between tyre and surface and axle load on the one hand, and the deceleration factor (related to acceleration of specific gravity) on the other.

In all cases, the characteristics depict the artic in a number of cases widely applying in practice.

The basis was the following data:

Axle load in N	laden	unladen
tractor, front axle	65,640	50,200
tractor, rear axle	94,750	35,335
semi-trailer 1st axle	79,760	24,280
semi-trailer 2nd axle	79,760	24,280

The braking pressure to the semi-trailer speeds 0.7 bar ahead of that on the tractor. When the truck is empty the braking pressure to the tractor's rear axle is controlled by an automatic load brake apportioner with a radial characteristic. On the semi-trailer, the braking pressure can be contained by means of a hand operated control of the quick-acting type.

Some notes to the diagram

1.1.1. Service brake intact, laden (Annex 8).

Owing to the absence of weight compensation in the semi-trailer's tandem set, the semi-trailer's second axle locks first.

1.1.2. Service brake intact, unladen (Annex 8).

Here, the effect is shown of the hand-operated control on the semi-trailer. Until the point of switching, the braking force distribution remains unchanged, and thus the braking capacities are the same, whether laden or unladen, until the switching point.

The diagram shows that the switching point is at $k = 0.8$ for axle No. 4 and at $K = 0.4$ for axle No. 3. The diagram is therefore valid only if the maximum braking force coefficient is greater than 0.8. In this case, axle No. 4 will not lock. If the maximum braking capacity coefficient is less than 0.8, axle No. 4 will lock quickly, and in addition the braking capacity will be lower ($\mu_{xb} < \mu_{xm}$).

In order to obtain a given deceleration, therefore, axles Nos. 1 and 2 must brake more strongly than indicated in the diagram. On a smooth surface ($\mu_{xm} \approx 0.35$ and $\mu_{xb} \approx 0.20$) axles Nos. 3 and 4 will allready lock before the switching point is reached, and hence the control will be ineffective. Axles Nos. 1 and 2 will then have to supply the braking capacity for higher decelerations, when axle No. 2 is still relieved by the semi-trailer pushing ahead. Axle No. 2 will therefore lock quickly on a smooth surface, and hence it makes no difference whether the hand-operated control is positioned "fully loaded" or "empty".

1.2. Tractor fails, semi-trailer brakes normally (Annex 9). In order to obtain reasonable deceleration, there will have to be a high friction coefficient.

There will be a great danger of the semi-trailer pulling off course.

1.3. Tractor fails, semi-trailer brakes normally (Annex 10). This leads to a dangerous situation because the tractor's rear axle is liable to lock quickly.

It makes little difference whether the vehicle is loaded or not. E.E.C. regulations permit a simple single-circuit system for the rear vehicle, as set forth in Section IV.

1.4.1. Tractor's front axle fails, laden (Annex 11).

In this situation reasonable deceleration is possible. Owing to speeding towards the semi-trailer, the tractor's rear axle will be the last to lock.

1.4.2. Tractor's front axle fails, unladen (Annex 11).

Owing to the semi-trailer's quick-acting regulator and the ALR with

a radial characteristic on the tractor's rear axle, this case differs little from 1.2.1. (tractor fails, unladen).

1.5. Tractor's rear axle fails (Annex 12).

When the vehicle is empty, this situation will be much better than if the front axle fails.

2. Measurement results

The result of each measurement was ascertainable from:

1. the observation sheet
2. the paper strip from the UV recorder.

The observation sheet not only showed precise data on temperature, braking path etc., but also observations by the driver or his mate regarding stability etc. See Annex 13. Where necessary, this information was incorporated in the results.

Besides the factors mentioned in section VIII.3, the following factors were also determined:

- 1) The build-up time t_A of the braking system (The time elapsing between depressing the brake pedal and the moment at which pressure begins to build up in the brake cylinder).
- 2) The time t_{75} in which the pressure in the brake cylinder reaches 75 per cent of the final pressure.

These two latter facts can be used only for comparison, because the addition of valves and piping makes the circuit times in the system differ from those under normal conditions.

Since the maximum deceleration only occurred for a very brief time in a large number of measurements, an average deceleration a_{gem} was defined:

$$a_{gem} = \frac{V_0}{t}$$

in which V_0 = speed at commencement of braking
 t = duration of measurement

Annex 14 shows part of a measurement strip with the twelve signals. Annex 15 shows a sheet with the result of several measurements worked out.

The results will be given for main and sub groups as mentioned in annexes 3, 4 and 5. For easy comparison the deceleration figures are given as an average deceleration a_{gem} for four measurements, that is at 40 and 80 km/hr both on dry and wet road surfaces. When desirable differences are given, too.

3. Group 1

3.1. Solo tractor

A normally braked tractor remains stable and the average deceleration for the four measurements was ample at 4.6 m/s^2 .

If the front axle fails there are indications of very great instability if the rear axle locks, as on a wet surface. The average deceleration was 2 m/s^2 .

Failure of the rear axle caused no problems. The front wheels locked, which may affect vehicle control. The average deceleration was 3.75 m/s^2 .

All diagonal brakings were very unstable. Average deceleration 2.4 m/s^2 .

It was impossible to correct diagonal brakings.

3.2. Tractor with unladen semi-trailer

This combination normally causes no problems. Average deceleration 4.6 m/s^2 . Locking of axle 3 as calculated in par. IX.1 (necessary friction more than 0.8; available friction 0.7) does not occur.

The braking force at the semi-trailer's axles probably was smaller as calculated. Wear of the brakes results in a bigger stroke and smaller braking forces.

Failure of a tractor axle causes no problems. A semi-trailer braked normally at that moment apparently kept the combination stable. A diagonally braked tractor causes an unstable combination pulling strongly to the left. Jackknifing occurs if the steering is not corrected.

Failure of one axle on the semi-trailer greatly relieves axle 2, causing it to lock especially on a wet surface. The combination will then jackknife.

A diagonal circuit on the semi-trailer again causes stability problems. But the reason in this case is that the semi-trailer is not adequately braked, so that axle 2 is relieved.

If only the tractor is braked, axle 2 locks and the combination jackknifes. Braking the semi-trailer alone gives a stable combination, but a low a_{gem} of 1.6 m/s^2 .

3.3. Tractor with loaded semi-trailer

As expected, normal braking causes no problems relative to the criteria. Even if a tractor axle failed (with a normally braked semi-trailer), stability was still good (similarly to an empty combination).

A diagonal circuit on the tractor did not cause the big stability problems of the empty combination. A slight correction in steering met the stability criterion.

Failure of one semi-trailer axle had no serious effects on stability, similarly to a diagonal circuit.

Failure of the semi-trailer's or the tractor's brakes caused no problems, apart from correcting the steering in the former case. But the a_{gem} seems rather low.

3.4. Conclusions

In nearly all the cases dealt with, the average deceleration after a circuit failure was still adequate. For completeness, a list is given below showing the a_{gem} (in m/sec^2) for four measurements:

Solo tractor: normal braking	4.6	
failure of axle 1	2	
failure of axle 2	3.75	
braked diagonally	2.4	
Combination:	<u>empty</u>	<u>fully loaded</u>
braked normally	4.6	4.1
failure axle 1	2.6	2.9

	<u>empty</u>	<u>fully loaded</u>
failure axle 2	3.9	2.9
diagonal circuit	3.1	3.0
tractor		
failure axle 3	3.8	3.1
failure axle 4	4.2	3.5
diagonal circuit	4.0	3.2
semi-trailer		
failure semi-	3.4	2.3
trailer brakes		
failure tractor	1.6	2.3
brakes		

The biggest problems in emergency braking are in vehicle stability rather than in deceleration, though this is sometimes very low.

It is striking in this connection that diagonal circuit separation has little to offer.

Furthermore, this research has again demonstrated the great danger of locking wheels. Especially locking of the second axle causes problems. It is striking that an inadequately braked semi-trailer pushes forward, relieving the second axle. In such a case an ALR on this axle does not hold the vehicle back enough and wheel locking occurs.

In view of the foregoing, the difference in a_{gem} if axle 3 or 4 fails is very striking. Owing to the weight transfer in the tandem set, axle 3 makes a much bigger contribution to deceleration than axle 4.

4. Main group 2

4.1. Solo tractor

As regards stability, only the measurements in which the front axle was braked were good. In the other three cases (see Annex 3) axle 2 locked and the vehicle was very unstable.

The average deceleration for four measurements in the former

case was adequate at 3.4 m/sec^2 .

4.2. Tractor with unloaded semi-tractor

a) With intact semi-trailer and auxiliary brakes on tractor: The results in this case are the same as for the solo tractor. Only if the first axle is braked with the auxiliary brakes is stability good, with an a_{gem} of 3.2 m/sec^2 ;

b) With intact tractor and auxiliary brakes on semi-trailer: If axles 3 and 4 are braked, stability is good. Diagonal braking is still reasonable, but braking only axle 3 or 4 causes stability problems.

c) If all the axles of the combination are braked with spring brake actuators, axle 2 will lock and severe instability effects occur.

4.3. Tractor with loaded semi-trailer

a) With intact semi-trailer and auxiliary brakes on tractor: Diagonal brakes on the tractor do not give good results. Braking axle 1 or 2 or both goes well.

b) With intact tractor and auxiliary brakes on semi-trailer. Except for an odd correction of steering, stability remained good in these measurements.

c) If all the combination's axles are braked stability remains good.

4.4. Conclusions

The average deceleration (m/sec^2) for main group 2 were:

Solo tractor: Axles 1 and 2 braked	3.5
Only axle 1 braked	3.4
Only axle 2 braked	3.4.
Diagonal braking	2.5.

For the combination with:	Intact semi-trailer		Intact tractor	
	Empty	Fully loaded	Empty	Fully loaded
Axles 1 and 2 (or 3 and 4) auxiliary brakes	3.5	3.4	4.8	3.7
Only axle 1 (or 3) brakes	3.2	2.7	3.6	2.8
Only axle 2 (or 4) brakes	2.7	2.8	3.9	2.9
Diagonal braking	2.9	2.7	3.8	2.8

All axles with spring brake actuators applied: Empty 4.1
Fully loaded 2.9

The average deceleration are adequate, but in this main group as well, stability is not as good as it ought to be. One reason is that braking power per axle cannot be regulated, and for instance axle 2 in the solo tractor or the empty combination is braked to the maximum, causing locking and instability. Braking power can be regulated for all axles at the same time with the auxiliary brake.

Another reason for poor stability is the relieving of axle 2 through the semi-trailer pushing forward. Another thing disclosed by the measurements was that the steering is difficult to correct because the driver has to handle the steering wheel with one hand and the auxiliary brake with the other.

5. Main group 3

5.1. Solo tractor

In this sub-group measurements were made with a tied-up ALR control arm. It appears that this makes the pressure to the 2nd axle too high and the wheels will then lock. Stability is very poor especially if only axle 2 is braked.

5.2. Tractor with unloaded semi-trailer

- a) Only ALR tied up: stability very poor owing to locking of axle 2;
- b) Only the brake regulator on the semi-trailer at "full". No problems on a dry road. On a wet road axle 2 locks, followed by instability.
- c) Both regulators at "full". The same result as in (a). The combination was very unstable.

5.3. Tractor with loaded semi-trailer

ALR on tractor at "full": Jackknifing occurs through locking of axle 2, thus failing to meet the stability criterion.

5.4. Conclusions

The average decelerations in this main group were:

Solo tractor with tied-up load brake apportioner:

Axle 1 and 2 braked	4.9
Only axle 2 braked	1.9

Combination:	Empty	Loaded
Tied up ALR	4.0	4.1
Manual regulator valve at "Full"	5.2	
Both regulator at "Full"	4.7	

If only the solo tractor's rear axle is braked to the full, the deceleration is too low. This is due mainly to the wheels locking. In other cases the a_{gem} is adequate.

A defect in the ALR, so that it passes on the maximum pressure during braking, has the consequence that axle 2 will lock regularly. The excessive pressure is not the only cause, because locking is also encouraged by the ALR no longer regulating dynamically.

An incorrectly adjusted regulator on the semi-trailer (i.e. at "Full with an empty combination) causes the braked wheels to lock; the semi-trailer provides too little braking power and pushes forward so that axle 2 is relieved. Especially on a wet road, the ALR will not hold the vehicle back enough and axle 2 will lock.

X. CONCLUSIONS AND RECOMMENDATIONS

In evaluating systems for emergency braking if the service brake fails, the criteria were braking path, the appropriate average deceleration and the track stability. In addition, attention was paid to lost times and possibilities of correcting the steering.

If the service brake functions normally, an articulated vehicle both loaded and unloaded proved to satisfy the criteria of deceleration and stability, even if the brakes were fully applied. This was found to be possible only if there was an automatic load brake apportioner on the tractor's rear axle. If this is not fitted, as is still the case with many of the present vehicles, or if it fails, the artic is very unstable and will usually jackknife if the brakes are fully applied.

With an intact service brake the solo tractor shows minor signs of instability at the end of the braking path on a wet surface. This is due to the limited possibility of regulating the load-related brakes. Without this facility, a solo tractor is very unstable under all conditions.

If the service brake becomes defective, part of the braking capacity may be retained because this brake has a residual effect or because hand-operated auxiliary brakes are installed. With nearly all applicable systems it was possible to reach the minimum deceleration of 2.2 m/s^2 needed to satisfy the requirements for the auxiliary brake's braking path. Exceptions were:

- circuit separation, with the tractor and semi-trailer each forming a circuit.

If the tractor's brakes fail, very long braking paths occur.

- if the solo tractor is braked only on the rear axle.

The practical tests showed that the biggest problem in emergency braking is the vehicle's track stability rather than deceleration. In braking with spring brake actuators, this happens because in

this case braking capacity is independent of the vehicle's load. With such actuators, braking capacity distribution is not regulated, and wheel-locking often occurs if the vehicle is unloaded. The vehicle is unstable:

- if the tractor's rear wheels lock. The artic then usually jackknifes or a solo tractor turns round its vertical axis.
- if the semi-trailer in an artic does not brake sufficiently. The semi-trailer then pushes forward, taking the load off the tractor's rear axle, and easily causes jackknifing.
- if diagonal circuit separation is applied to the tractor, i.e. to the right front wheel and the left rear wheel or vice versa. The vehicle then pulls off course, and cannot be corrected owing to the big difference in braking capacity at the front and rear axles, so that a strong turning moment occurs in the tractor.

If we examine the present requirements concerning brakes in Regulations 71/320/EEC, 74/132/EEC and 75/524/EEC in the light of these findings, serious gaps are found to exist:

- a vehicle combination as a whole need not undergo braking tests. Each vehicle individually has to satisfy the criterion of deceleration, since separate braking systems as between tractor and semi-trailer are permitted by the present EEC requirements.
- track stability is guaranteed only if the semi-trailer continues to brake sufficiently. According to the present requirements in the above-mentioned directives, trailers and semi-trailers need not be equipped with auxiliary brakes. Nor need the service brake of the trailer or semi-trailer have any residual effect except if the automatic load brake apportioner fails.
- track stability is the main criterion for the auxiliary brakes and/or the residual effect of the service brake. No requirements are given for track stability in case of emergency braking. Instability occurs especially on wet road surfaces. Wheel-locking during braking tests on other than dry surfaces are not provided for in the present regulations.
- the hand-operated brake-pressure control of the quick-acting type on a semi-trailer only has any purpose on a reasonably rough

surface. This control may also be of some use if there are low braking capacities on the semi-trailer (owing to wear). On a smooth surface the semi-trailer's wheels are already locked before the control acts, and its value under these conditions is dubious.

Theoretical considerations and practical tests have shown that the total time lost when using separate hand-operated auxiliary brakes is greater than if the residual effect of the service brake is used. Moreover, hand-operated auxiliary brakes have the drawback that the driver has to take one hand from the steering wheel. Experience shows that it is then difficult, if not impossible, to correct the steering. Furthermore, it has not been proved that using spring brake actuators as auxiliary brakes produces higher decelerations than with the residual effect of the service brake, while it is then that the greater loss of time has to be compensated for.

All the above findings are based, as far as practical tests are concerned, on tests made under specific conditions.

Even when wet, the road surface still gave fairly good braking force coefficients. The vehicle's behaviour on smoother surfaces than those used for the tests may not be quite as good as regards track stability.

Measurements were made only with one set of tyres of the same make. The difference between different makes of tyres, however, are not very great. A factor that had a somewhat adverse effect on the measurements was brake wear. This changes braking capacity distribution, and in particular makes it difficult to evaluate the semi-trailer's hand-operated brake-pressure control. It is therefore important, for such research, to adjust the brakes in good time, automatically or otherwise.

80 km/h was chosen as the top speed, because many countries have this limit for trucks. In practice, however, they often driver much faster.

The load was varied between fully loaded and empty.

In practice, of course, there are many intermediate conditions,

often including uneven loading.

Notwithstanding the limited scope of the research outlined above, a number of clear recommendations follow from these conclusions.

Recommendations

- The regulations should include a requirement regarding vehicle lateral stability when using auxiliary brakes or the service brake's residual effect.

Braking tests should be made on a wet surface with at least an empty artic and a solo tractor. The roughness of the wet road surface should be carefully defined.

- The regulations should include a requirement that trailers and semi-trailers should be equipped with auxiliary brakes or that the service brake should have a certain residual effect in case it fails.

- For both tractors and semi-trailers it is preferable, in case of emergency braking, to have a service brake residual effect of, say, 50% of the prescribed braking capacity.

- The use of systems in which half the braking capacity of each axle is always available for emergency braking is preferable.

- For more detailed research it is advisable to make smaller-scale tests than those described above, into the behaviour during emergency braking of a combination of truck and trailer.

REFERENCES

1. Traffic accidents and road surface skidding resistance. Institute for Road Safety Research, SWOV, 1975.
2. Fink, W. Verzugsdauer beim Bremsen. ATZ 70 (1968) no. 9.
3. Johansson, G. and Rumar, K. Driver's brake reaction times. The Department of Psychology, University of Uppsala, Sweden, March, 1965.

LIST OF APPENDICES

1. Measures and weights of the tractor and semi-trailer.
2. Outline of the added values of the tractor and semi-trailer.
3. Putline of circuit separation utilizing the residual effect of the service brake: Main group 1.
4. Outline of braked wheels utilizing spring brake actuators: Main group 2.
5. Outline of possible failures in the installed equipment for brake force distribution: Main group 3.
6. Measured brake force coefficient at the measuring site.
7. Block diagram of the equipment.
8. Relationship between the required friction coefficient K and axle load on the one hand, and the deceleration on the other for the normal braking system.
9. Relationship between the required friction coefficient K and axle load on the one hand, and the deceleration on the other when the tractor's braking system fails.
10. Relationship between the required friction coefficient K and axle load on the one hand, and the deceleration on the other when the semi-trailer's braking system fails.
11. Relationship between the required friction coefficient K and axle load on the one hand, and the deceleration on the other when the tractor's front axle fails.
12. Relationship between the required friction coefficient K and axle load on the one hand, and the deceleration on the other when the tractor's rear axle fails.

13. Example of an observation sheet.

14. Example of a paper strip from the UV recorder.

15. Worked out measuring results.

16. Illustration 1 + 2.

17. Illustration 3 + 4.

18. Illustration 5 + 6.

19. Illustration 7 + 8.

	F _{Z1}	F _{Z2}	F _{Z3}	Total
Solo tractor	48	23,8	-	71,8
Unladen combination	50,8	36,4	49,5	136,7
Laden combination	66,3	97,2	162,6	326,1

All loads in kN

Tractor: $X_1=1080, Y_1=950$

Semi-trailer	X_2	Y_2
Unladen	5710	1000
Laden	4800	1730

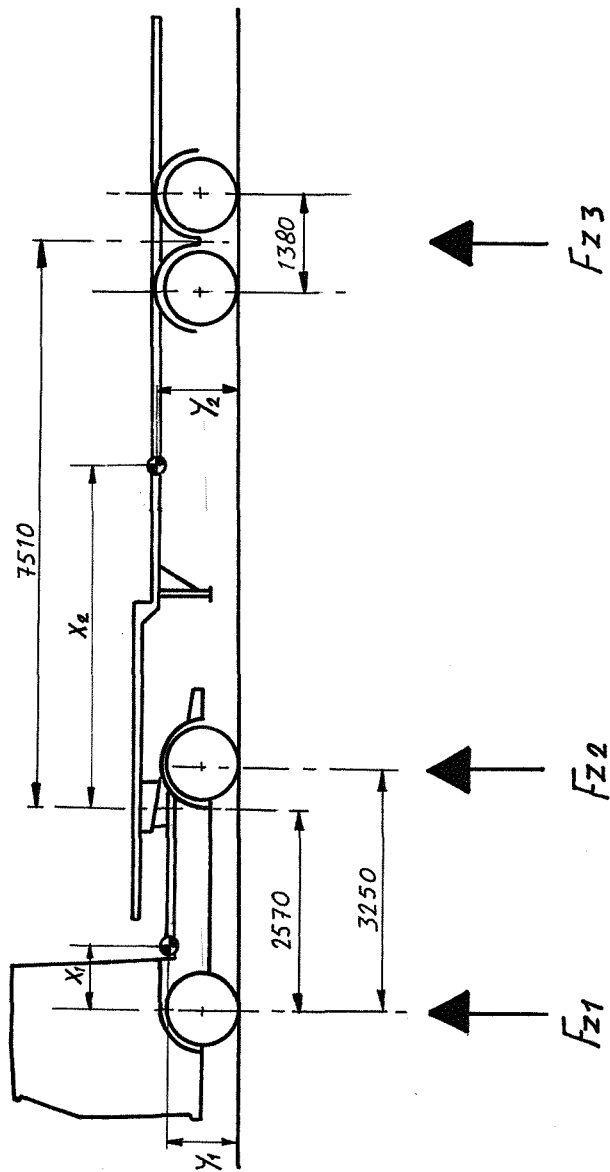

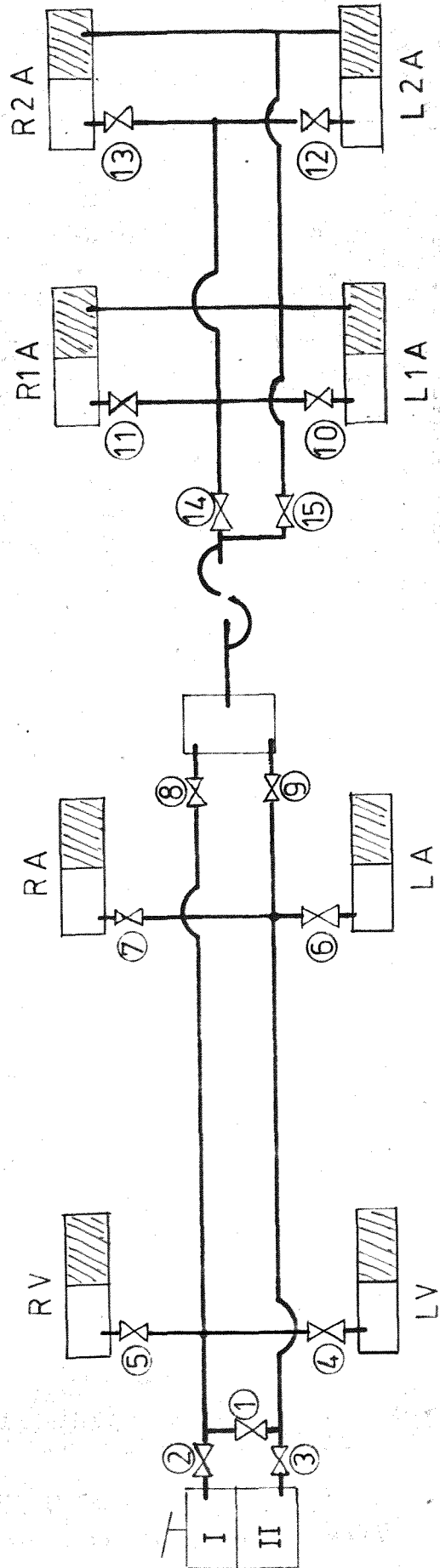

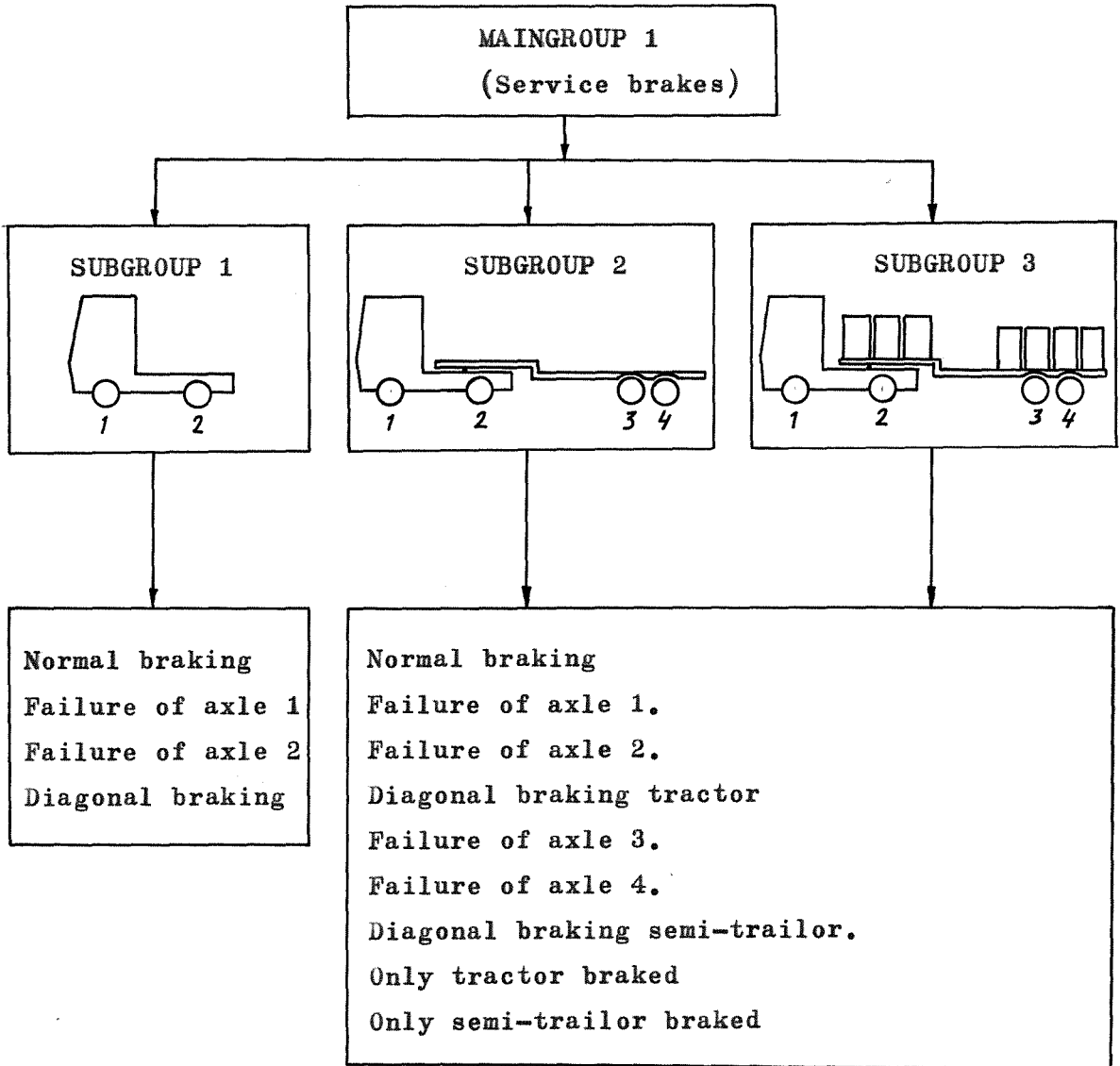

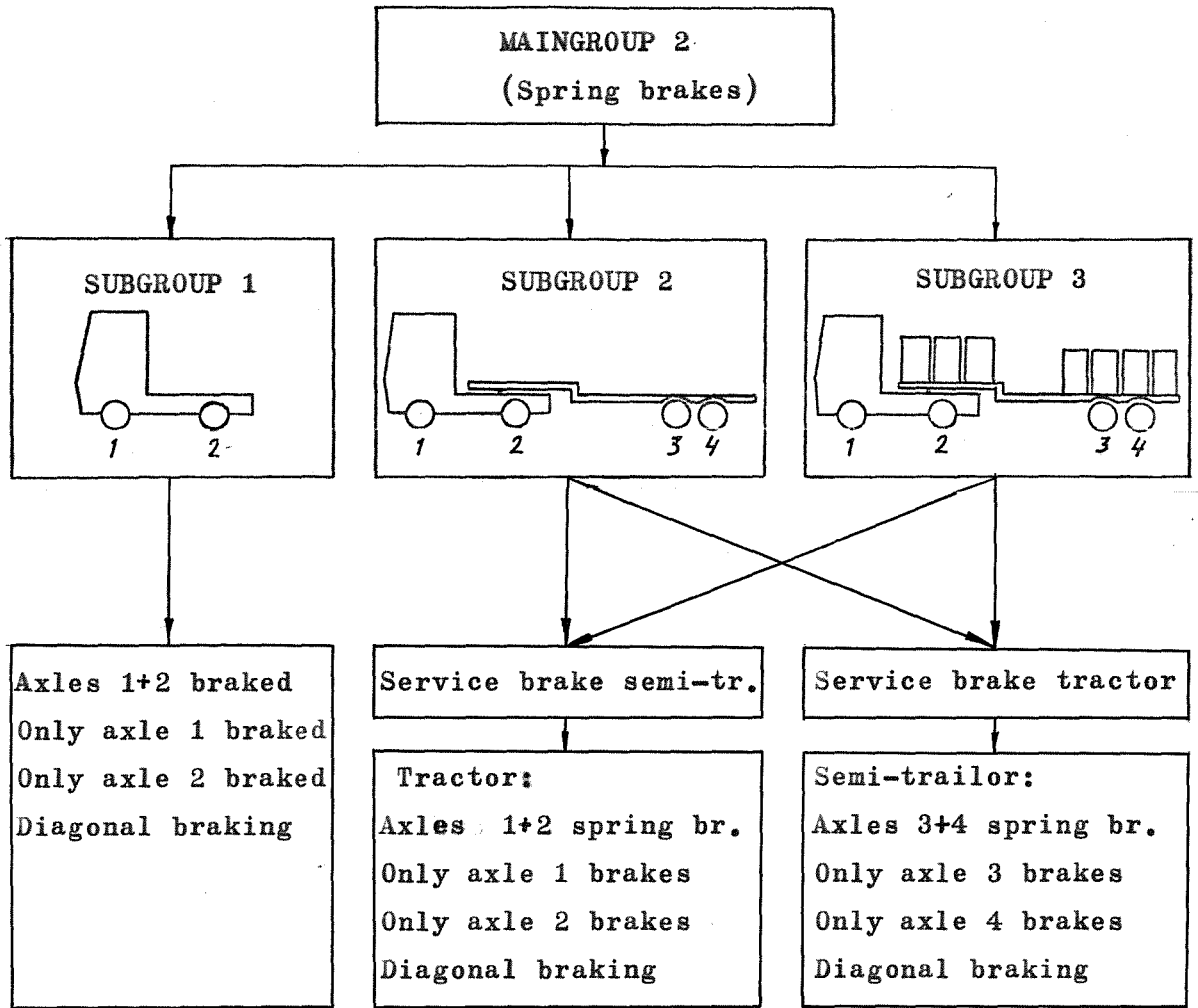

Also in this maingroup: All axles braked at the laden or unladen combination

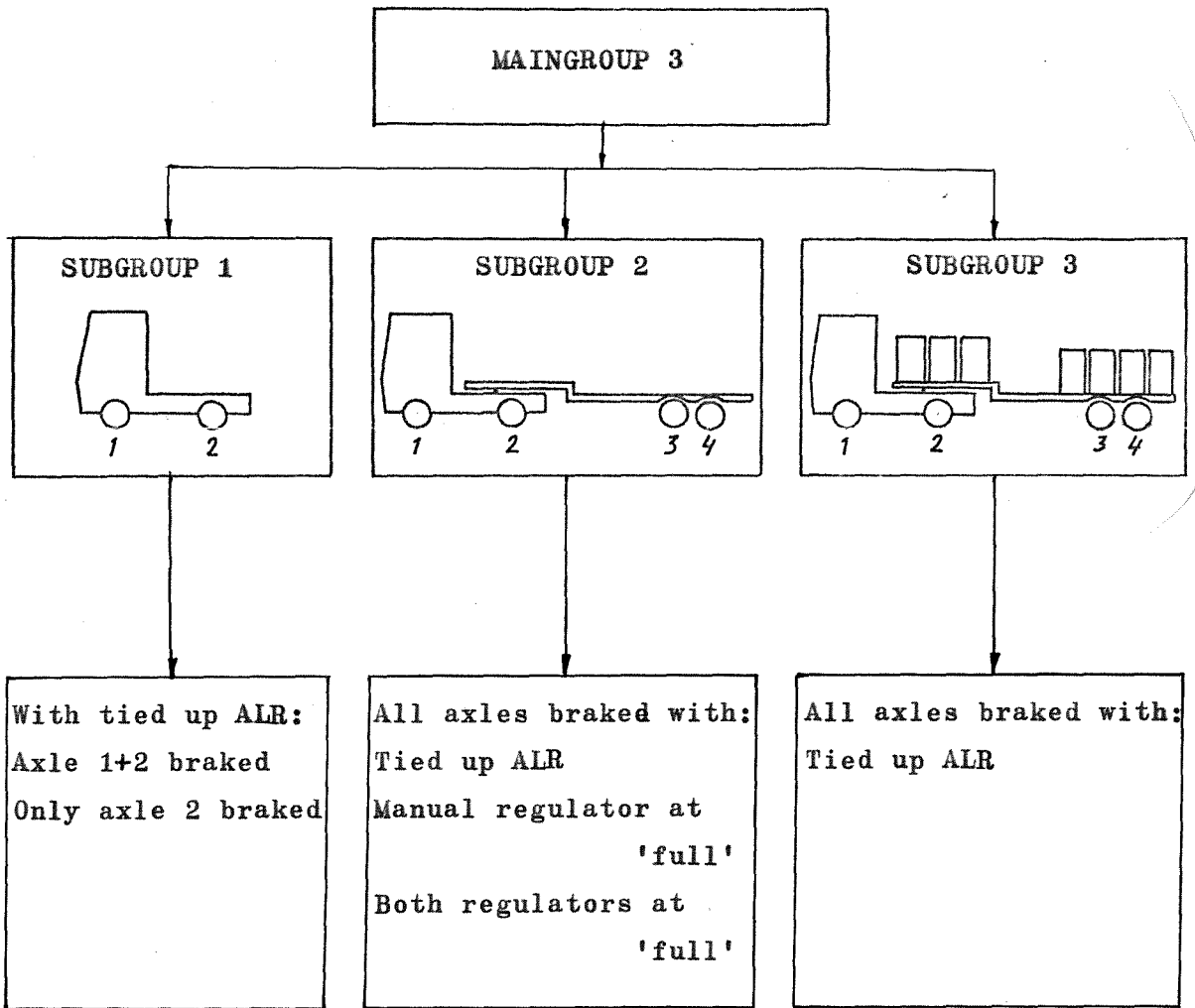

Tied up ALR means: The control arm of the ALR is fixed in the position 'full'

TEST RESULTS ENTER

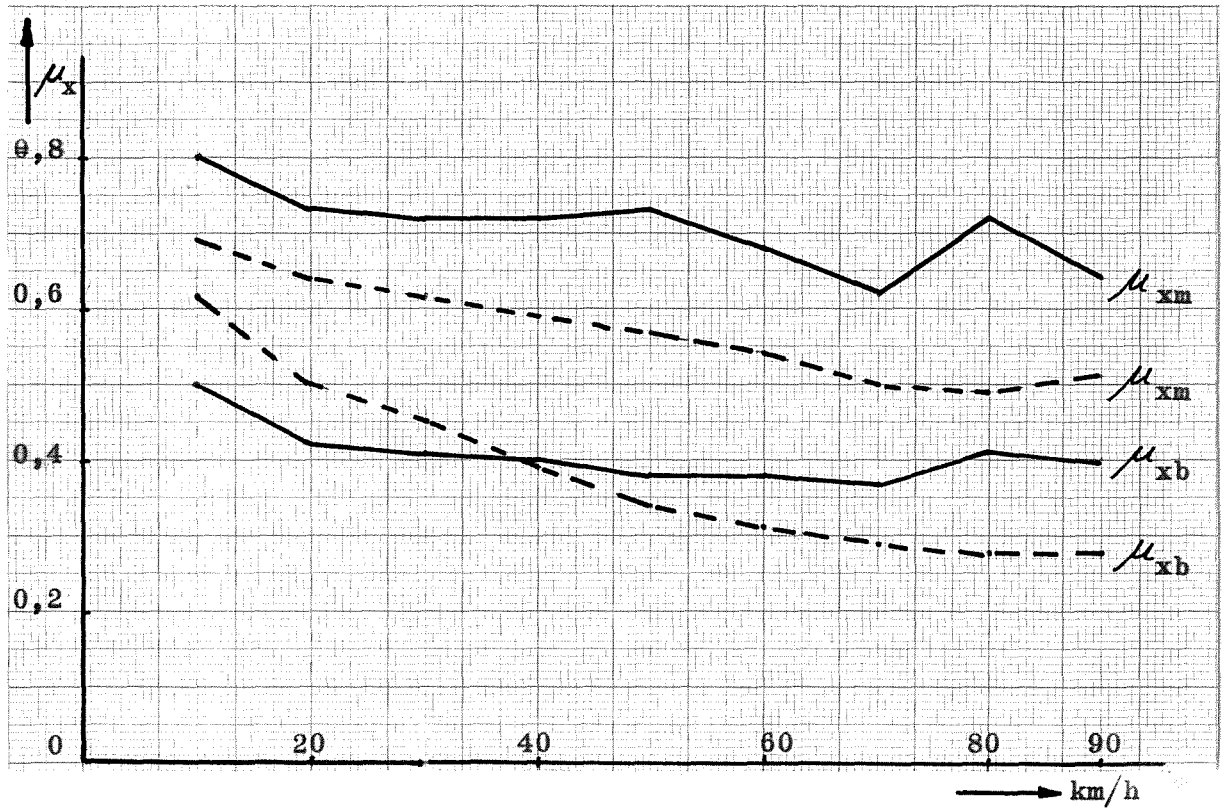

———— DRY

----- WET

TIRE: MICHELIN E 20 X

LOAD: 25500 N

PRESSURE: 6,25 BAR

BLOCK DIAGRAM OF THE EQUIPMENT

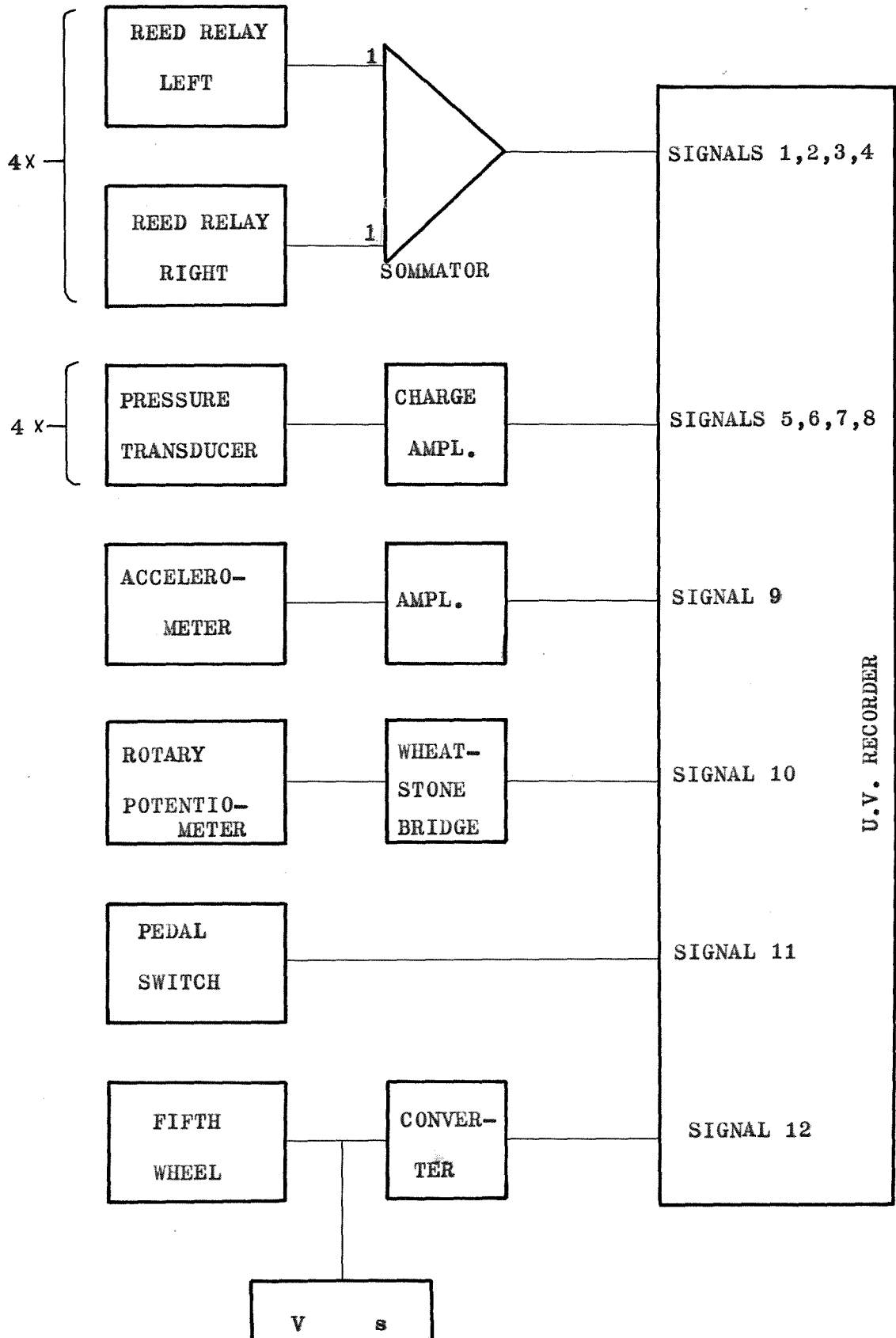

SERVICE BRAKES

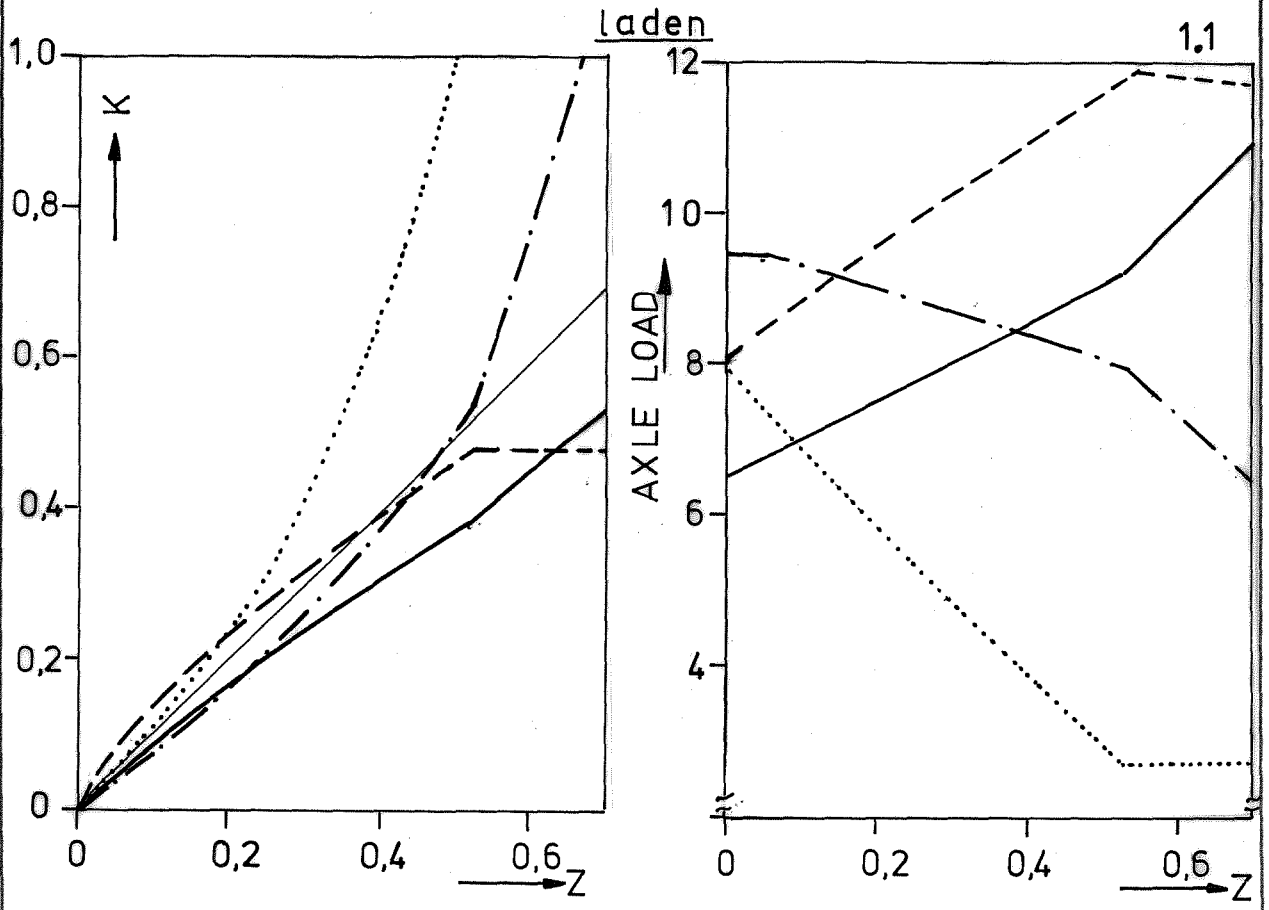

— FRONT AXLE - - - 1° SEMI TRAILER AXLE
- · - REAR AXLE ····· 2° SEMI TRAILER AXLE

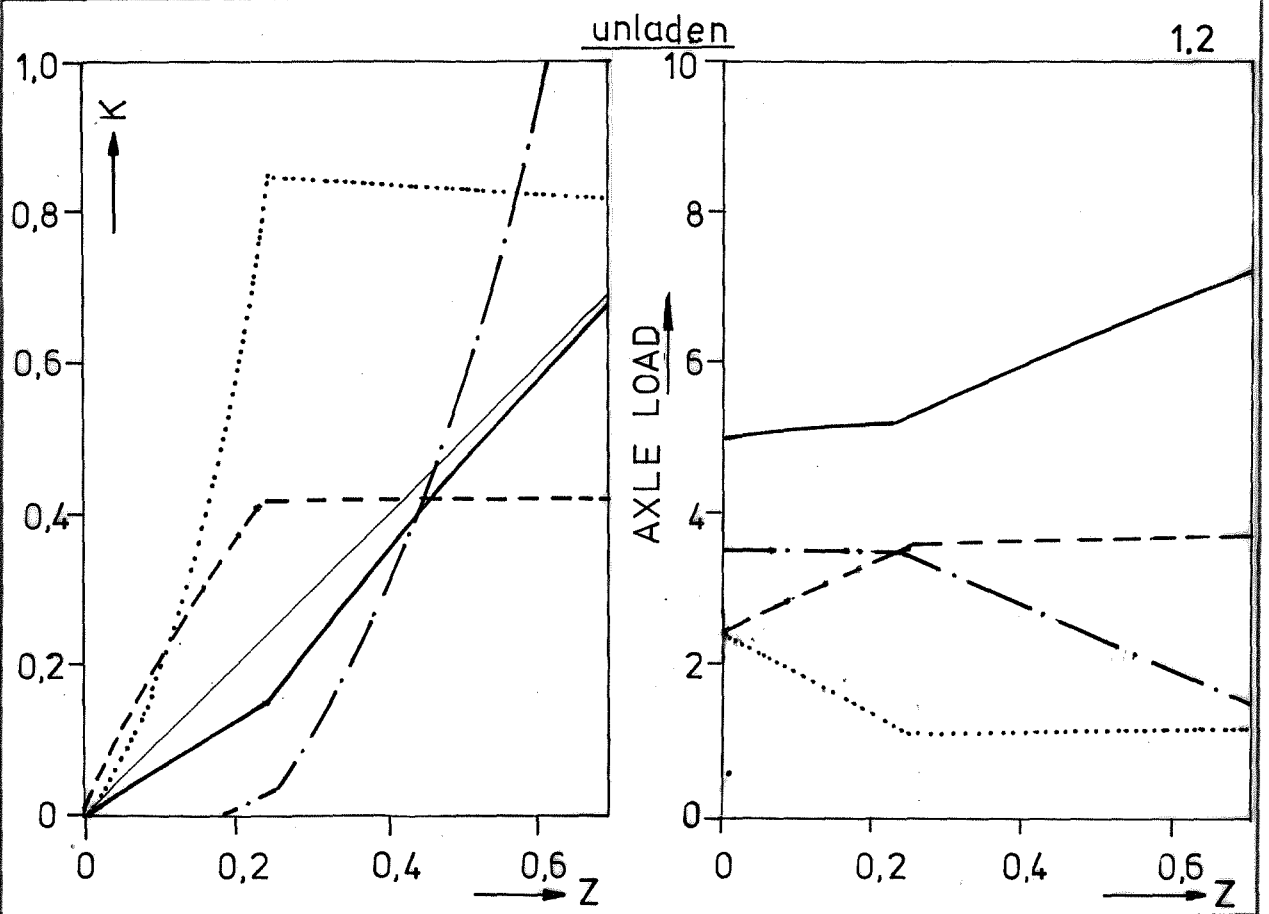

FAILURE TRACTOR

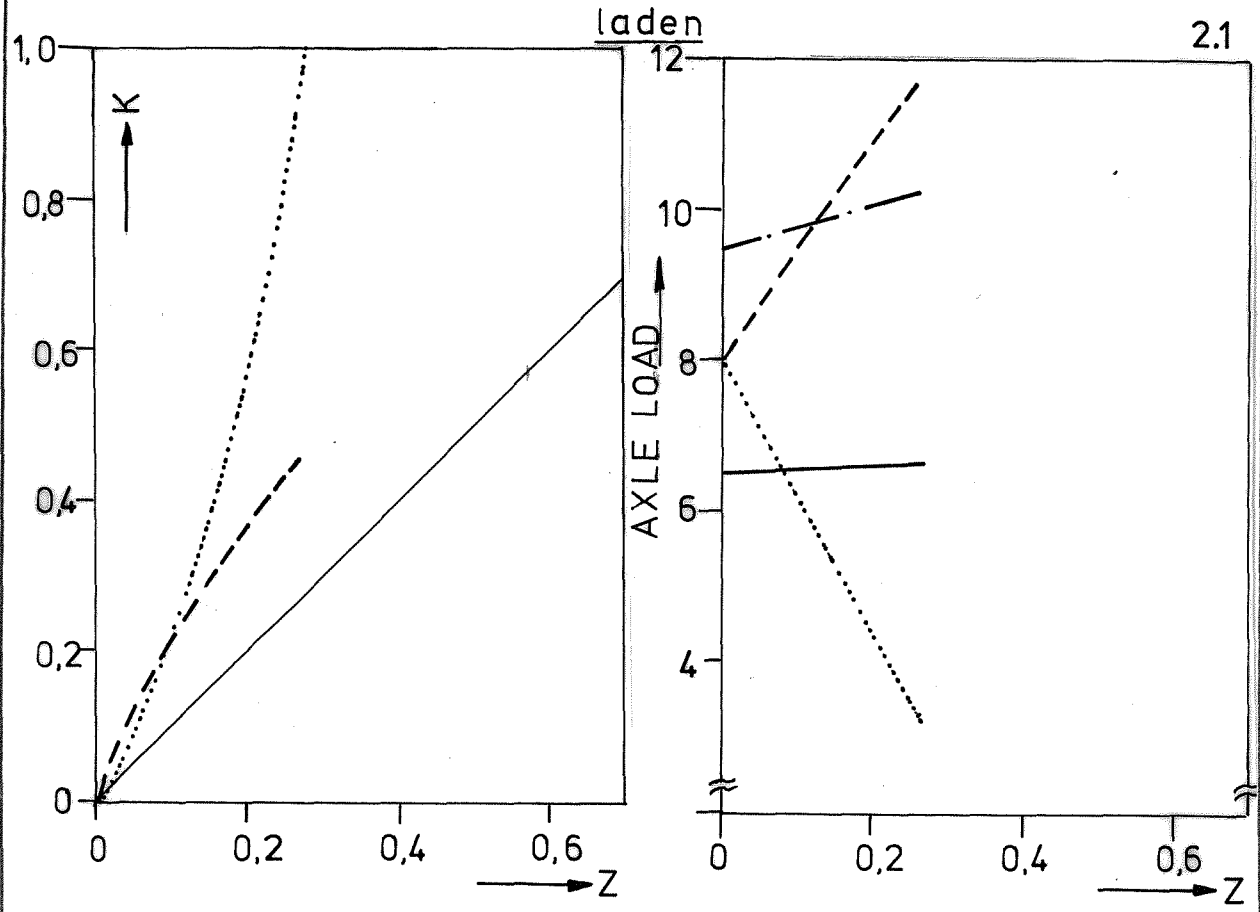

— FRONT AXLE - - - - 1° SEMI TRAILER AXLE
- . . . - REAR AXLE ······ 2° SEMI TRAILER AXLE

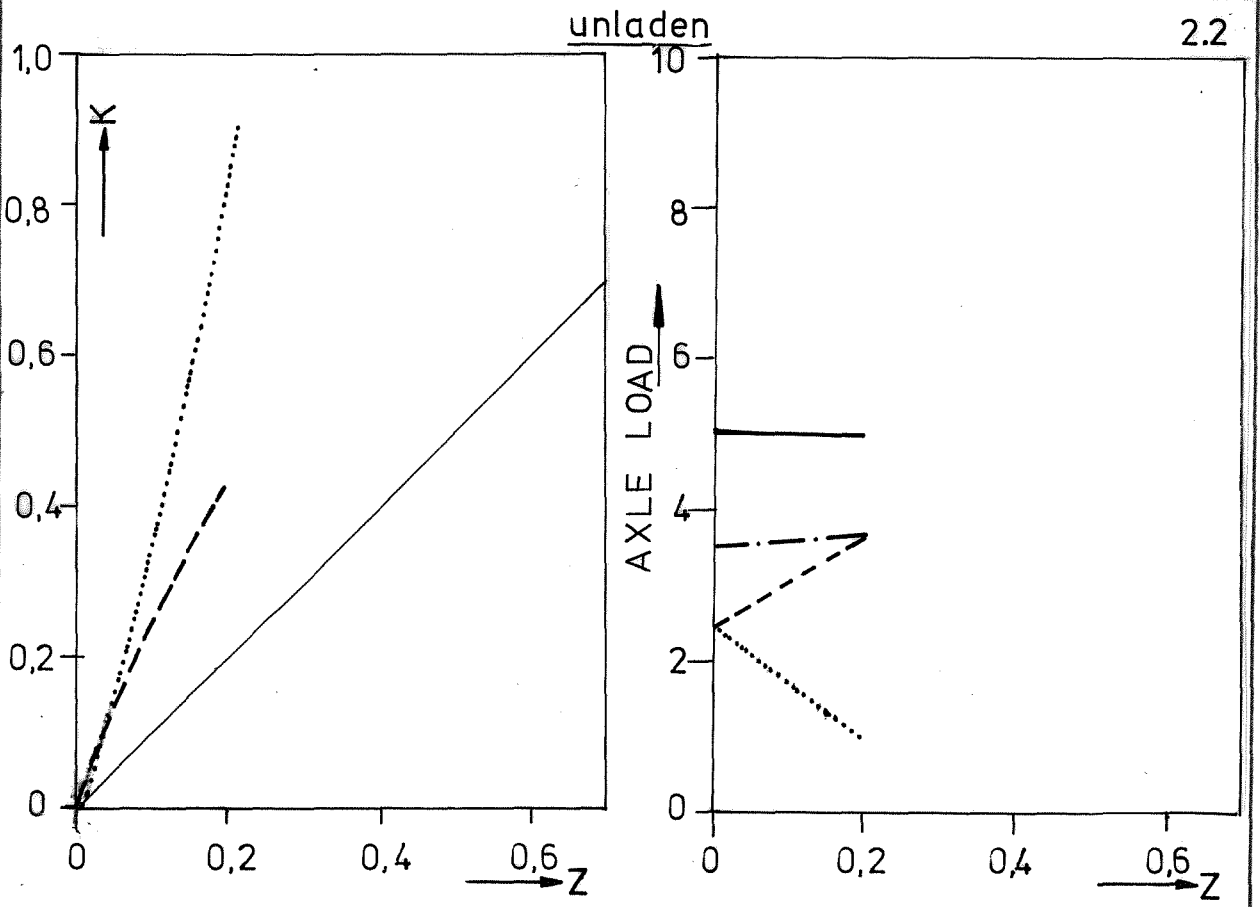

FAILURE SEMI TR.

laden

3.1

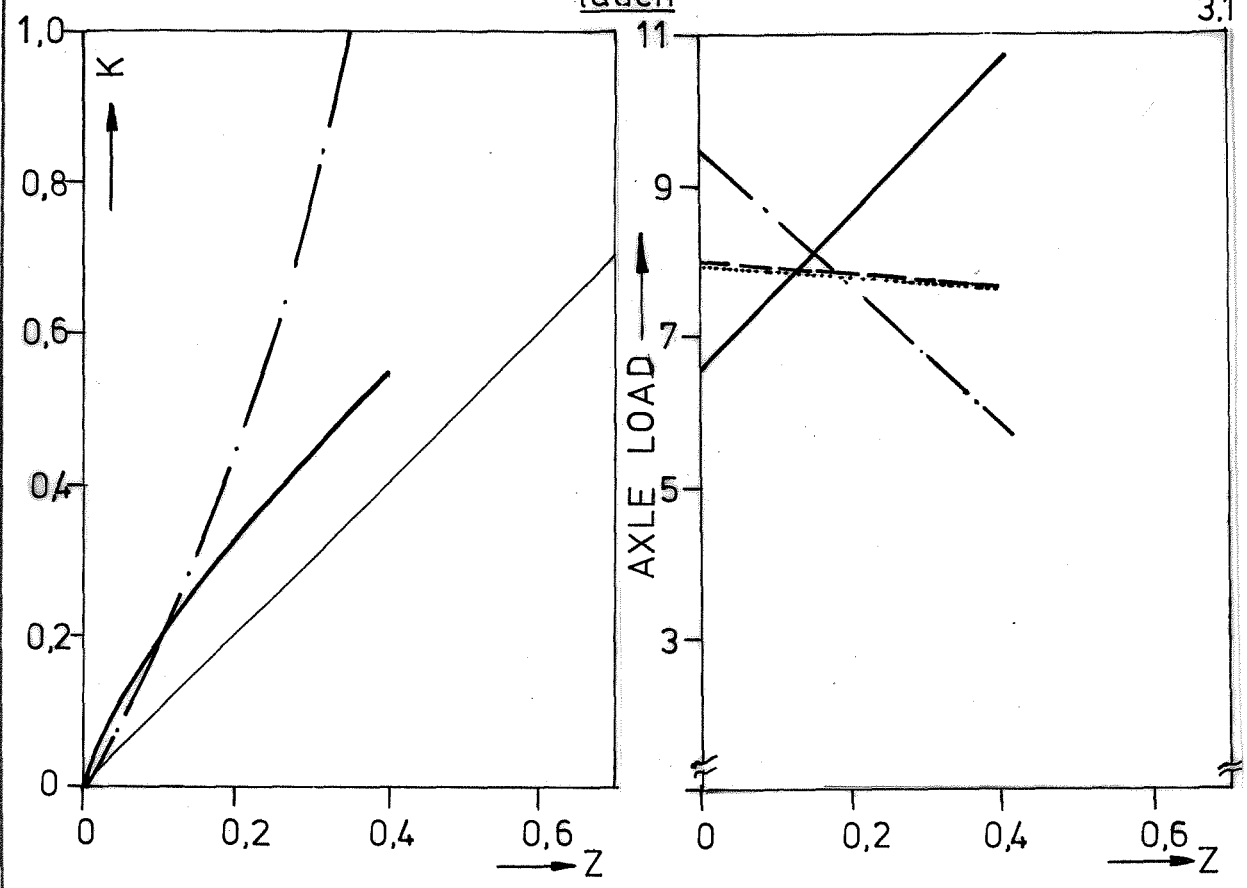

—— FRONT AXLE - - - - 1° SEMI TRAILER AXLE
- · - · - REAR AXLE · · · · · 2° SEMI TRAILER AXLE

unladen

3.2

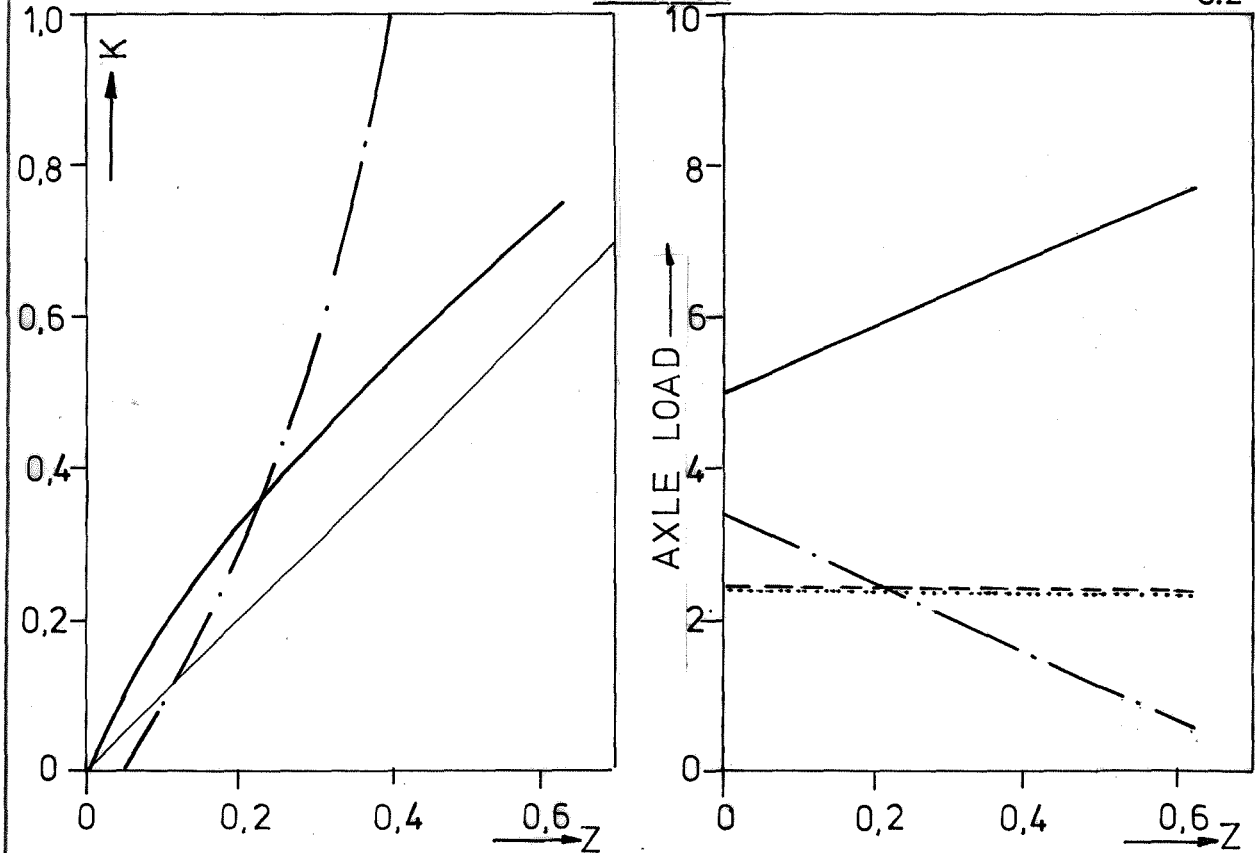

FAILURE FRONT AXLE

laden

4.1

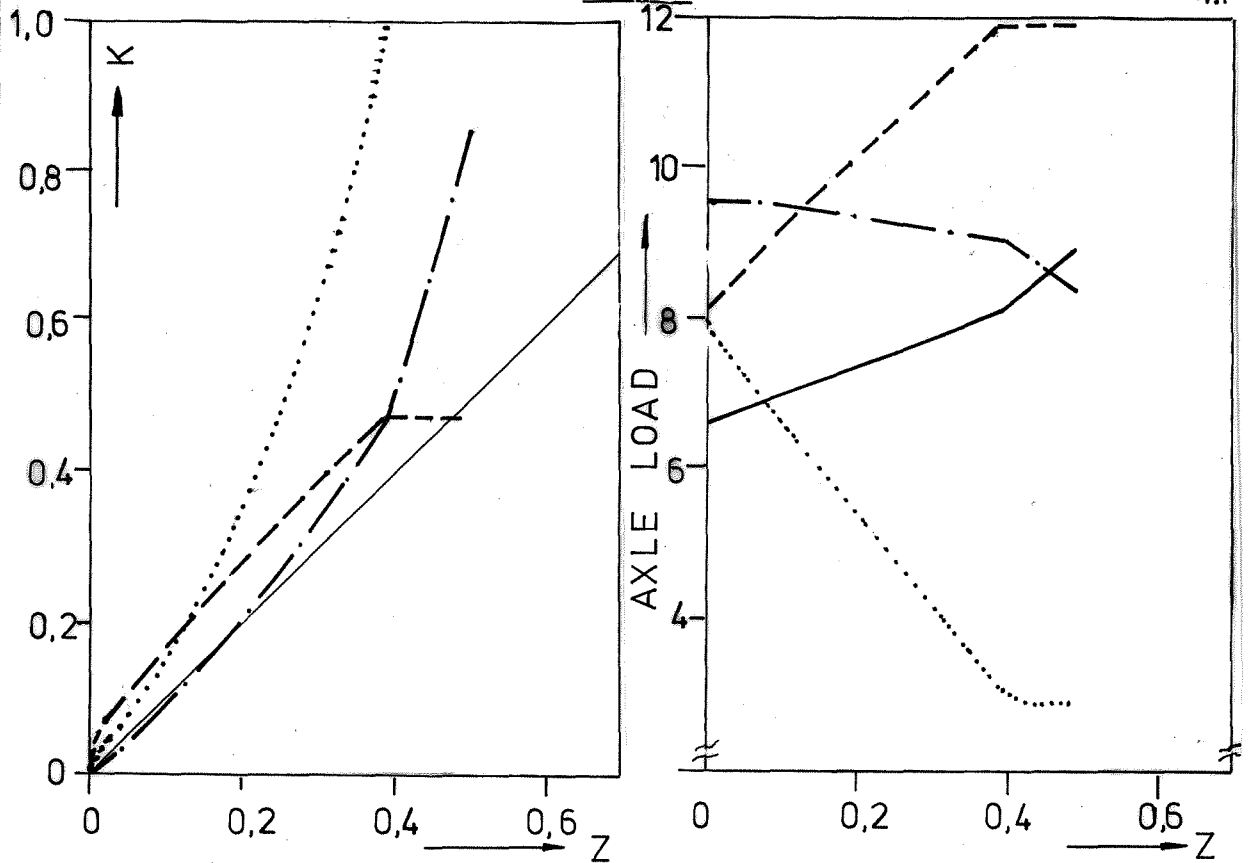

— FRONT AXLE - - - - 1° SEMI TRAILER AXLE
- · - · - REAR AXLE ······ 2° SEMI TRAILER AXLE

unladen

4.2

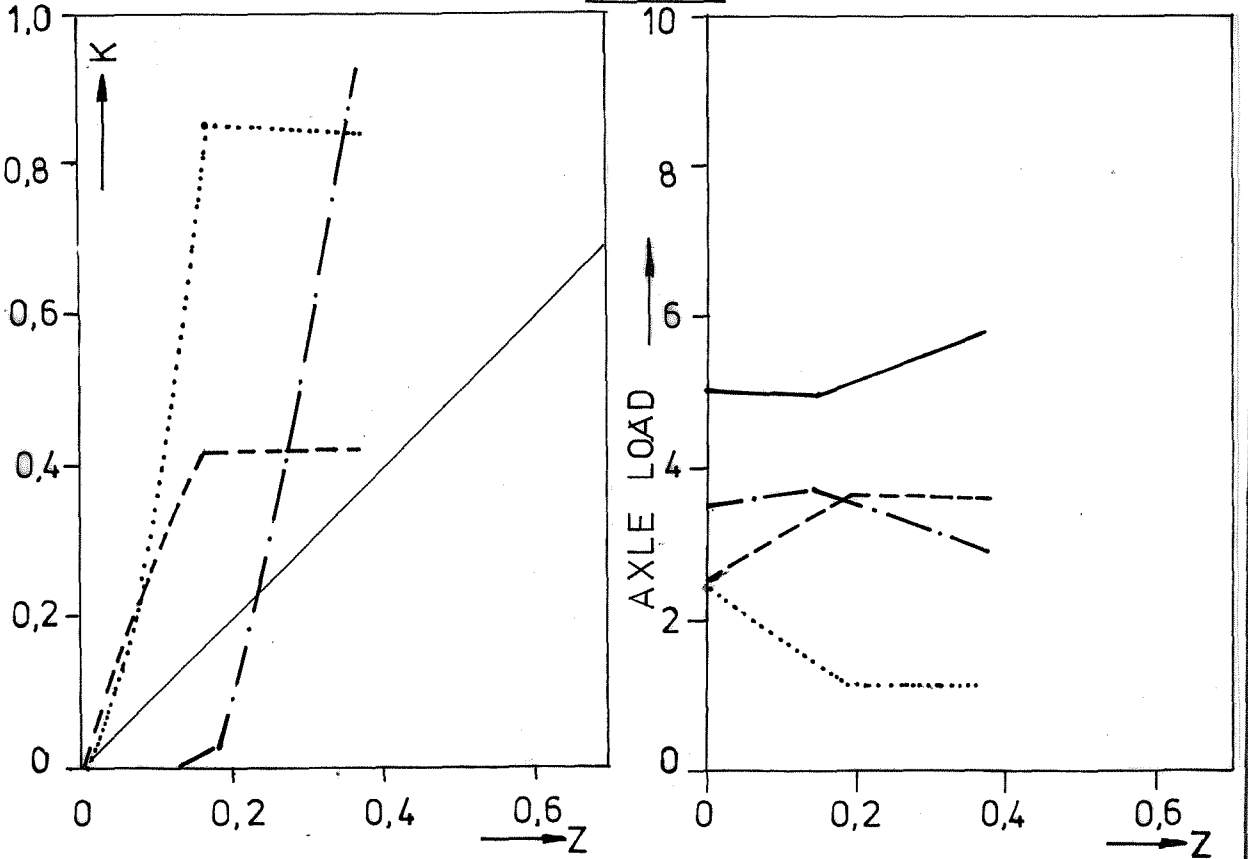

FAILURE REAR AXLE

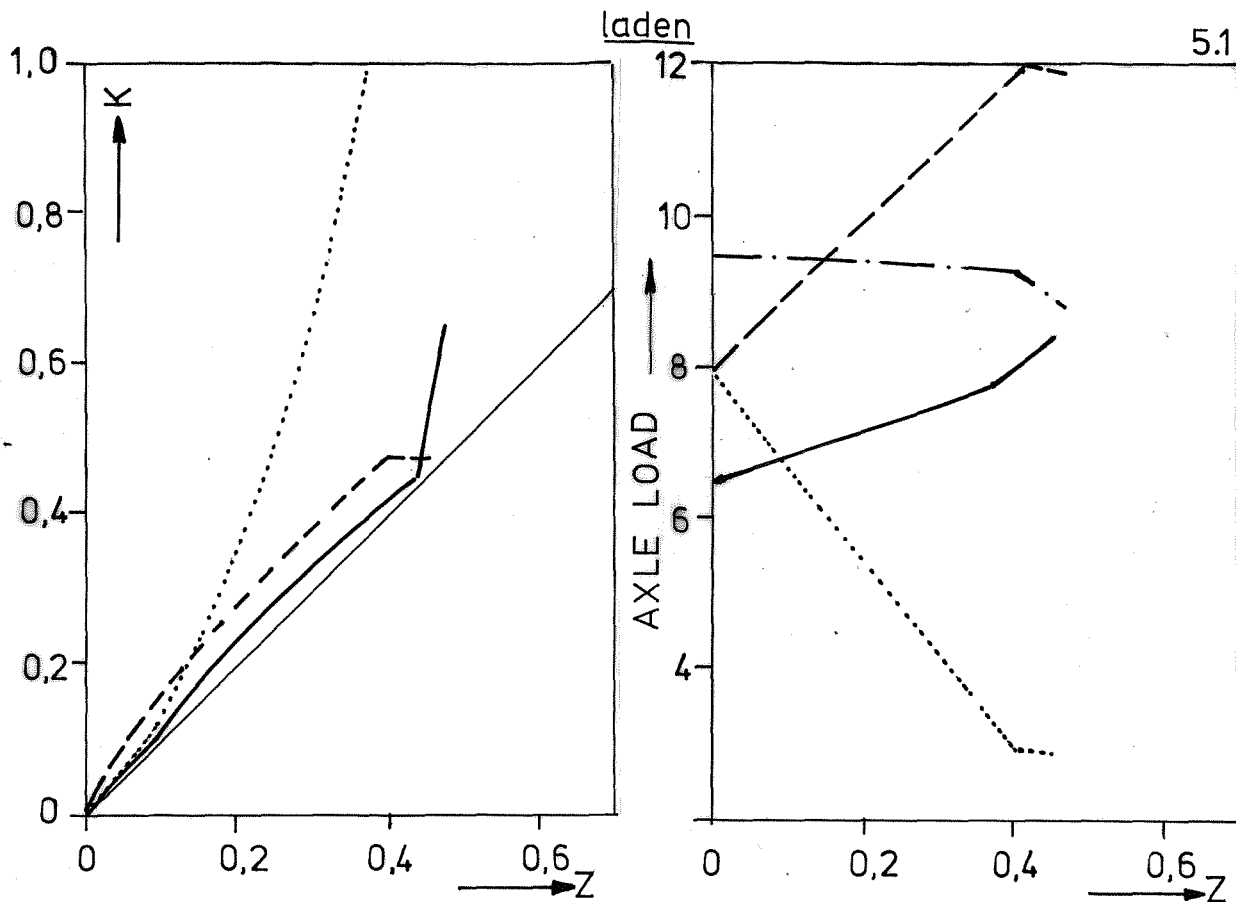

— FRONT AXLE - - - - 1° SEMI TRAILER AXLE
- · - · - REAR AXLE ······ 2° SEMI TRAILER AXLE

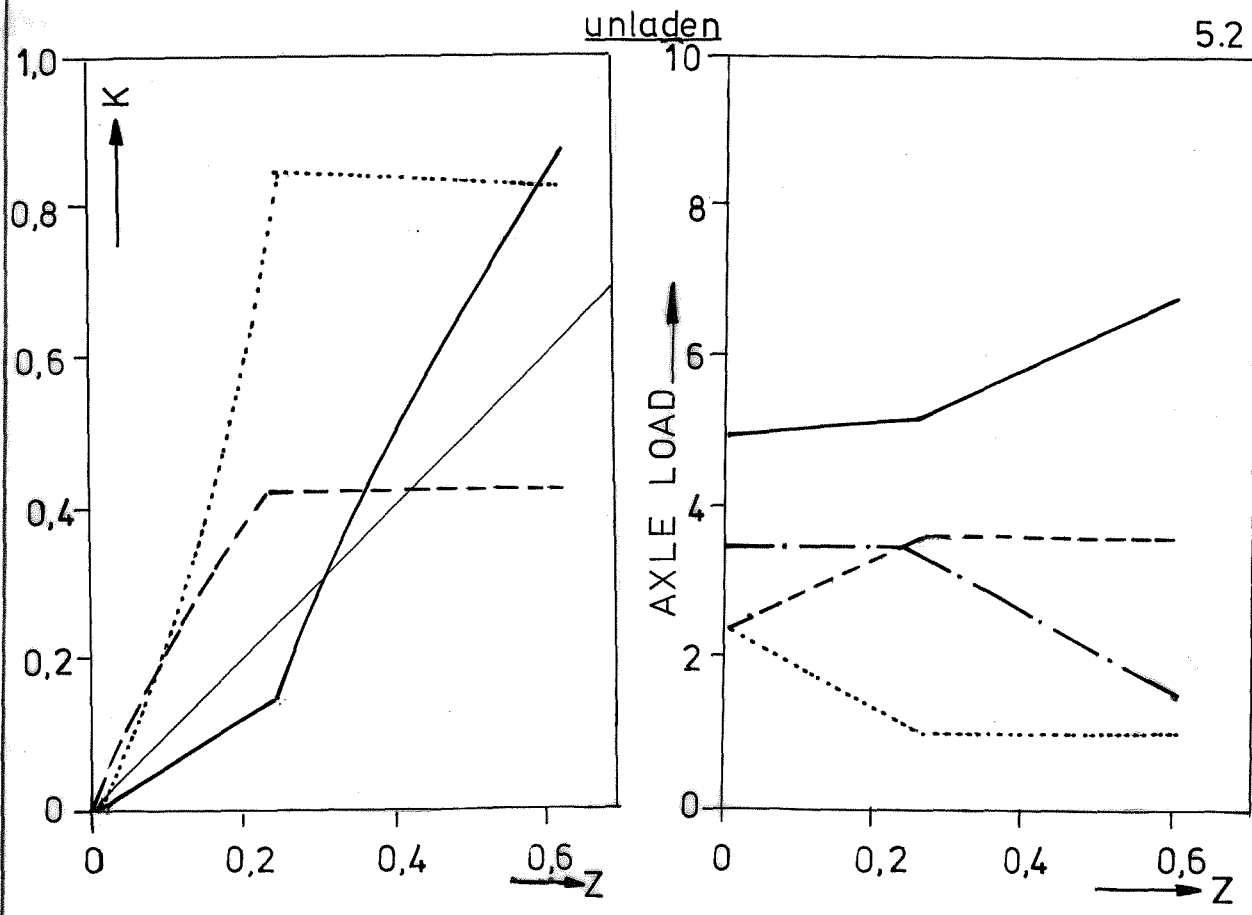

TEST NUMBER: 34

DATE: 15-9-75

UNLADEN LADEN

X	
---	--

DRY WET

X	
---	--

SPEED(km/h)

80

BRAKING DISTANCE(m) DISTANCES(m)

46

2.30

FRONT AXLE-ROAD SIDE

2.00

REAR AXLE - ROAD SIDE

3.30

2° SEMI-TRAILER AXLE - ROAD SIDE

TEMPERATURES °C

58

FRONT AXLE

45

REAR AXLE

52

1° SEMI-TRAILER AXLE

42

2° SEMI-TRAILER AXLE

POSITION COMBINATION END OF TEST

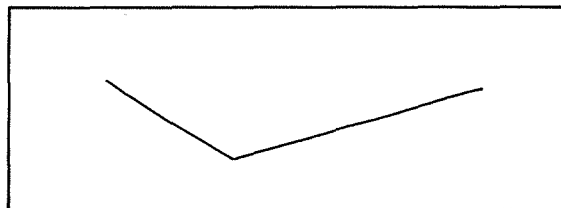

REMARKS: -

STABILITY: -

CORRECTION DRIVER NECESSARY? NO

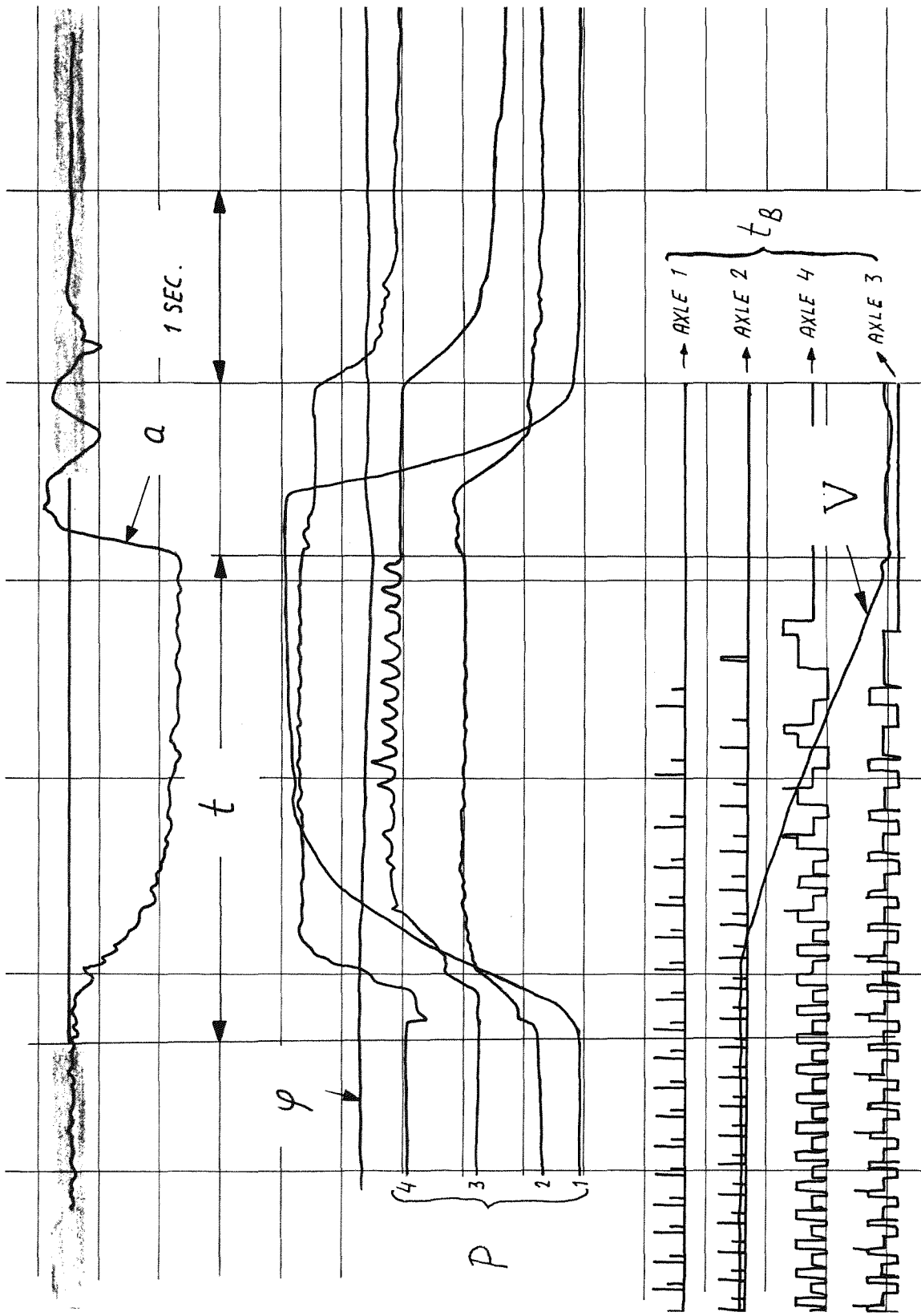

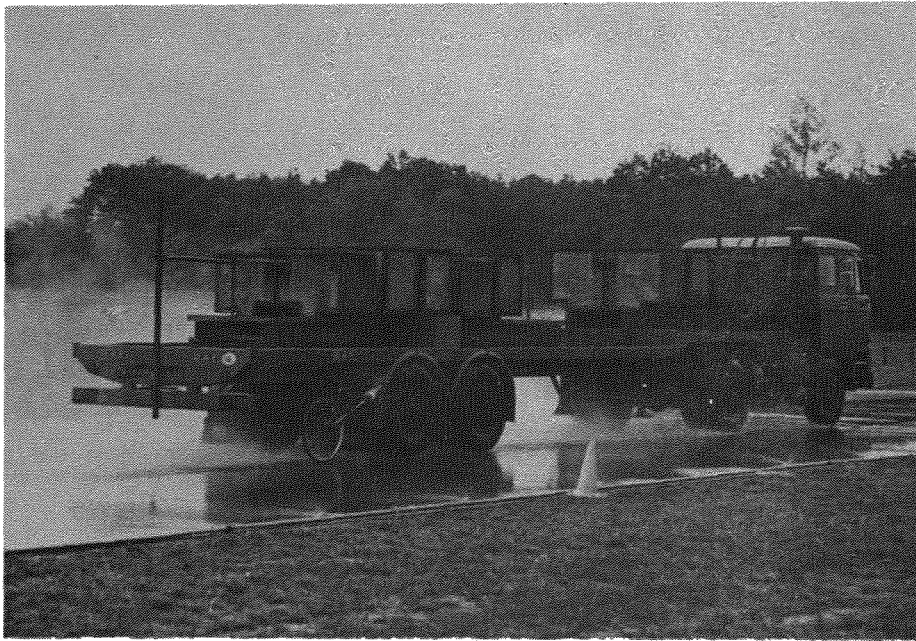

1

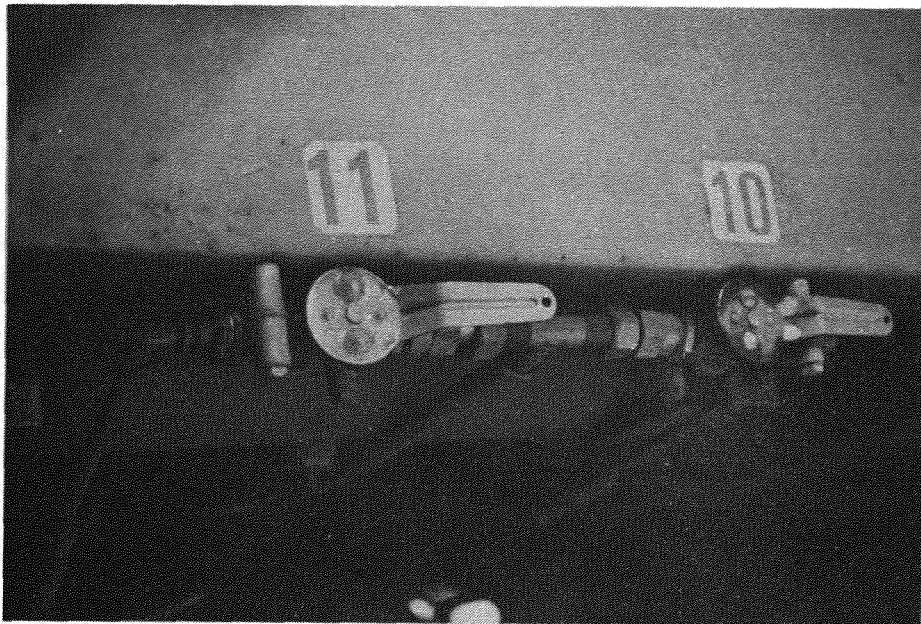

2

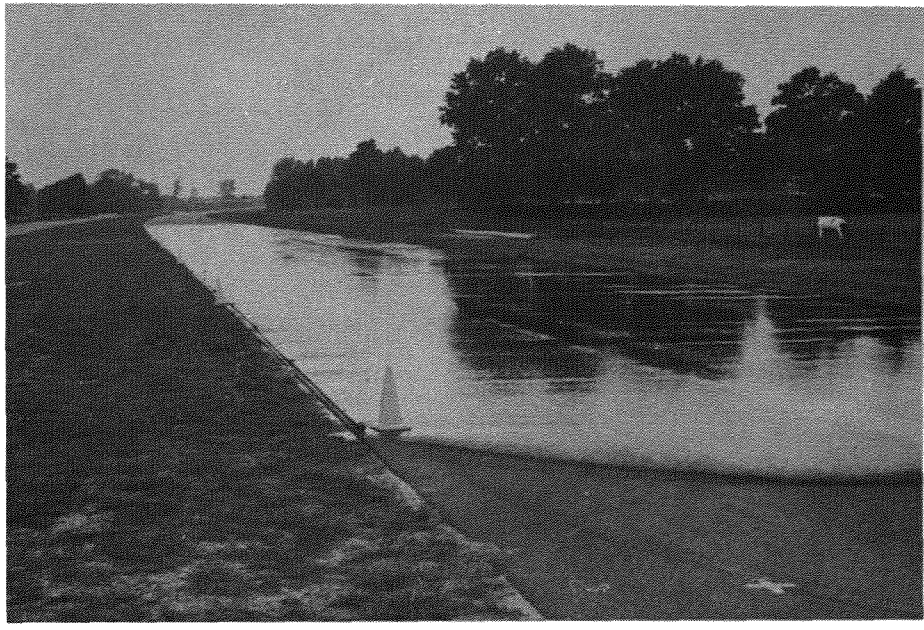

3

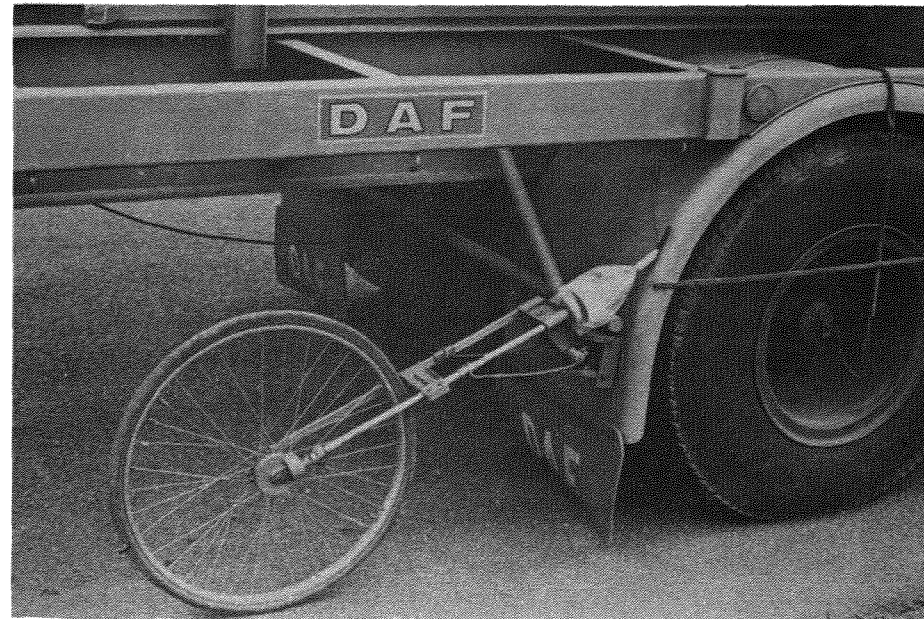

4



5

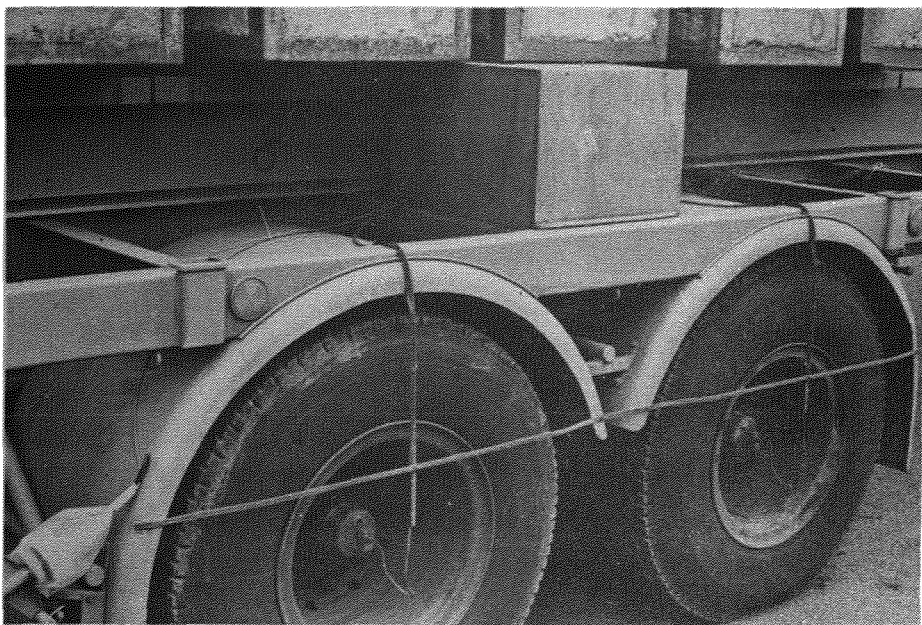

6



7

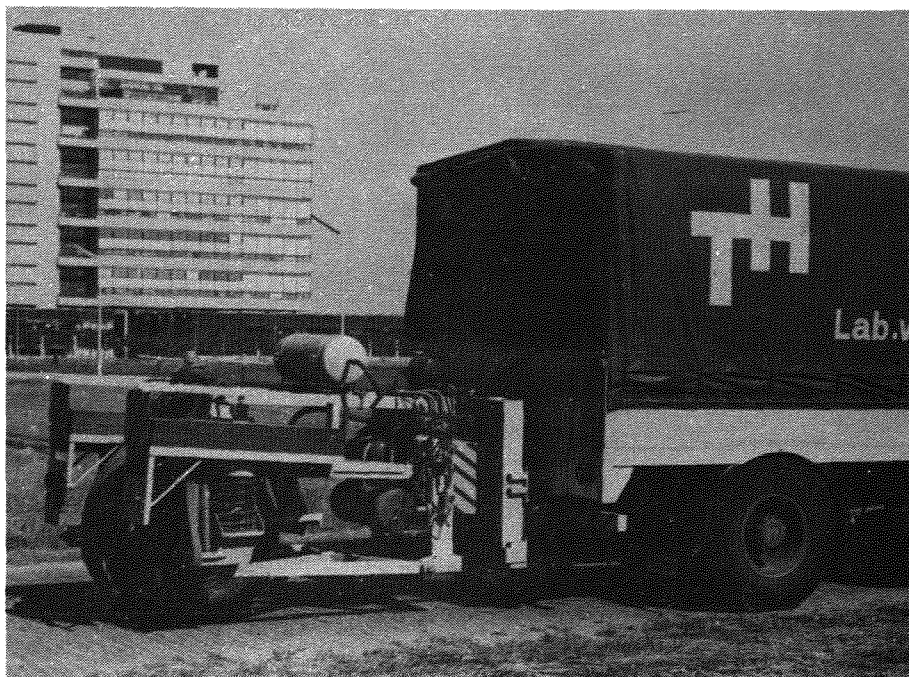

8